

本手册所有产品外观、颜色、参数仅供参考，最终以发出实物为准。  
我们保留随时更改产品技术和说明的权利，如有变动恕不另行通知。  
若有错误或不祥之处敬请谅解。  
本产品技术尺寸样本的版权及解释权均属本公司所有。

All product appearance, color and parameters of this manual are for reference only, and finally the object is given.  
We reserve the right to change the product technology and specifications at any time without further notice.  
If there is any error or inauspicious place to be forgiven;  
The copyright and interpretation rights of this product's technical dimension are all owned by the company.

专注于  
专用车  
半挂车  
厢车  
冷藏车  
环卫车  
工程车

南挂  
NANGUA  
NANGUA®

## Truck and Trailer & lamps and Parts

产品图册  
J版



### 常州市南挂车辆部件有限公司

内销 地址：江苏省常州市新北区孟河镇工业园  
电话：0519-83550298 83550710 85511931  
传真：0519-83550198  
Http://www.nangua-cn.com  
E-mail:nangua@nangua-cn.com

### CHANGZHOU NANGUA VEHICLE PARTS CO.,LTD

外贸 Add:Menghe Industrial Park Xinbei Area,Changzhou,Jiangsu  
Tel: 0086-519-83550520  
Fax: 0086-519-83550198  
Http://www.nangua-cn.com  
E-mail:nangua@nangua-cn.com



扫一扫，了解更多新品



常州市南挂车辆部件有限公司  
CHANGZHOU NANGUA VEHICLE PARTS CO.,LTD

常州市南挂车辆部件有限公司于1992年创办成立，地处江苏省常州市新北区孟河工业开发区，临近沿江高速、沪宁高速。公司拥有优秀员工队伍。公司设有技术部、销售部、质量部、制造部、管理部、财务部、采购部等职能部门，年生产能力5000万件。

公司系科研、开发、制造、销售为一体的高新技术企业。公司拥有完整的生产及检测设备，主要生产设备有：PEI、PC等卧式注塑机、自动多工位立式注塑机、超声波塑料焊接机等先进设备。现已开发生产经营汽车灯具、挡泥罩、汽车线束及其附件产品共有三大类别，400余个品种。灯具主要品种有：后雾灯、倒车灯、LED灯、后尾灯、标志灯及示廓灯、室内顶灯。挡泥罩主要有7.00-11.00规格，涵盖了轻卡到重卡的范围。线束主要有半挂车整体线束。

公司在致力于国内OEM市场的销售，同时也开拓国外市场。国内主要配套厂家有：中集车辆（CIMC深圳、扬州通华、山东、青岛中集等）、阜阳开乐、东风商用车有限公司等。公司以顾客为关注焦点，不断增强顾客满意，严格过程控制，追求零缺陷。

公司的拖车车灯产品在2003年全部通过CCC认证，部分车灯通过美国交通运输部DOT认证。

公司奉行“诚信为本、顾客至上、以顾客盈利为目的”的经营理念，愿与国内外客商携手合作共创美好未来！

## ABOUT US

Changzhou Nangua Vehicle Parts Co., Ltd is located in Menghe Industry Area, Changzhou New North District, Jiangsu, China nearby the Yanjiang and Huning highway, which was established in 1992. the company has excellent work teams. Our company has development & research, marketing, quality, manufacturing, administration, financing and purchasing Dept. meters of construction area, and the capability of 50 million units. The company is High-tech Enterprise with researching, developing, manufacturing, and marketing functions.

The company has complete production and testing equipment, the main production facilities are: the horizontal injection molding machines, automatic multi-vertical injection molding machines, ultrasonic welding plastics and other advanced equipments, such as PEI, PC and so on. We are dealing in the auto lamps, mud guards and vehicle harnesses, etc., three series products and more than 400 styles. The lighting products include Rear Fog lamps, Backup lamps, LED lamps, Tail lamps, Signal lamps, Outline Marker lamps and Room lamps. Mud guard has mainly 7.00-12.00 specifications, which is covered the light trucks to the heavy trucks scope. The harnesses are used for semi-trailer.

The company is trying to develop domestic marketing while eh- forcing the overseas marketing. The main domestic OEM customers include CIMC (Shenzhen, Yangzhou Tonghua, Shandong, and Qingdao), Fuyang Kaile, Dongfeng Commercial Vehicle Co., Ltd, and so on. The company focuses on the satisfaction of customers, continuously improve it, control process strictly and pursue zero defects.

Our products for domestic marketing all pass China Compulsory Certification (3C). Parts of auto lamps have passed function tests of seven (vibration, water, dust, corrosion, distortion, photometry and color) of American Transportation Department and pass DOT certification.

The company will regard "Credit basis, customers first and for the purpose of the customers profits", as the business policy and hope to cooperate with the clients all over the world for a glorious future.



## 企业资质 Certification certificate



公司的产品全部都通过权威部门的检测认证，出厂前我们也有严格检测手段，保证产品到客户的质量更加稳定可靠。

company's products all through the authoritative department certification testing, before delivery, we also have strict testing means, ensure the quality of the product to the customer is more stable and reliable.

先进的注塑组装工艺、为产品质量打好坚实的基础，确保产品出厂合格率100%

The advanced injection molding process, and the solid foundation for the quality of the product, ensure that the product is 100%



■ 大型数控加工中心



■ 数控精雕机



■ 电火花机

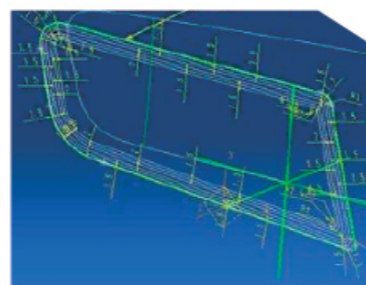

■ 数据设计中心

我们拥有精密模具零部件，采用国际先进的CAD/CAM一体化流程方案，已成为本地区规模最大，最专业的对外精密模具加工企业。力争在现有的基础上不断探索、不断创新、不断超越、以更优质、快捷的服务回报各位新老客户。

We have precision mould parts and international advanced CAD/CAM integration process, which has become the largest in the region. The most professional precision mold processing enterprise. Strive to explore constantly, innovate constantly, constantly surpass, improve the quality and speed The service of jie is in return for your new and old customers.



**NG01001 L/R**



**后组合灯 (泡式)**

型号: NG01001 L/R  
用途: 具有转向灯/制动灯/  
后位灯的功能  
灯泡型号: P21W(24V21W)、  
P21/5W(24V21/5W)

**3C认证产品**

Tail Lamps  
Type Number:NG01001 L/R  
Application:With the functions of the  
turn lamp,stop and rear position lamp  
Bulb Mode:P21W(24V21W)、  
P21/5W(24V21/5W)

**3C Authentication**

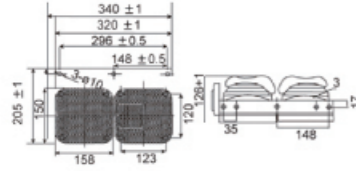

**NG01002 L/R**



**后组合灯 (泡式)**

型号: NG01002 L/R  
用途: 具有制动灯/后位灯/  
转向灯的功能  
灯泡型号: P21W(24V21W)、  
P21/5W(24V21/5W)

**3C认证产品**

Tail Lamps  
Type Number:NG01002 L/R  
Application:With the functions of the  
turn lamp,stop and rear position lamp  
Bulb Mode:P21W(24V21W)、  
P21/5W(24V21/5W)

**3C Authentication**

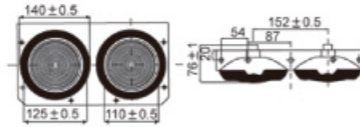

**NG01007 L/R**



**后组合灯 (泡式)**

型号: NG01007 L/R  
用途: 具有转向灯/制动灯/  
后位灯的功能  
灯泡型号: P21W(24V21W) × 2、  
P21/5W(24V21/5W)

**3C认证产品**

Tail Lamps  
Type Number:NG01007 L/R  
Application:With the functions of the  
turn lamp,rear position lamp and  
backup lamp  
Bulb Mode:P21W(24V21W) × 2、  
P21/5W(24V21/5W)

**3C Authentication**

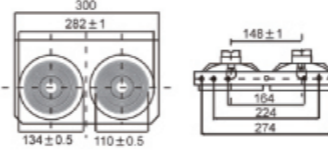

**NG01008 L/R**



**后组合灯 (泡式)**

型号: NG01008 L/R  
用途: 具有制动灯/后位灯/  
转向灯的功能  
灯泡型号: P21W(24V21W) × 2、  
P21/5W(24V21/5W)

**3C认证产品**

Tail Lamps  
Type Number:NG01008 L/R  
Application:With the functions of the  
turn lamp,rear position lamp and  
backup lamp  
Bulb Mode:P21W(24V21W) × 2、  
P21/5W(24V21/5W)

**3C Authentication**



**NG01003 L/R**



**后组合灯 (泡式)**

型号: NG01003 L/R  
用途: 具有转向灯/制动灯/后位灯/  
倒车灯的功能  
灯泡型号: P21W(24V21W) × 2、  
P21/5W(24V21/5W)

**3C认证产品**

Tail Lamps  
Type Number:NG01003 L/R  
Application:With the functions of the  
turn lamp,stop lamp, rear position  
lamp and backup lamp  
Bulb Mode:P21W(24V21W) × 2、  
P21/5W(24V21/5W)

**3C Authentication**

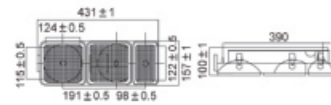

**NG01004 L/R**



**后组合灯 (泡式)**

型号: NG01004 L/R  
用途: 具有转向灯/制动灯/后位灯/  
倒车灯的功能  
灯泡型号: P21W(24V21W) × 2、  
P21/5W(24V21/5W)

**3C认证产品**

Tail Lamps  
Type Number:NG01004 L/R  
Application:With the functions of the  
turn lamp,stop lamp, rear position  
lamp and backup lamp  
Bulb Mode:P21W(24V21W) × 2、  
P21/5W(24V21/5W)

**3C Authentication**

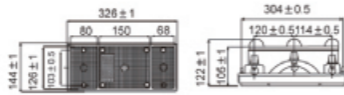

**NG01005 L/R**



**后组合灯 (泡式)**

型号: NG01005 L/R  
用途: 具有转向灯/制动灯/后位灯/  
倒车灯的功能  
灯泡型号: P21W(24V21W)、  
P21/5W(24V21/5W)

**3C认证产品**

Tail Lamps  
Type Number:NG01005 L/R  
Application:With the functions of the  
turn lamp,stop lamp, rear position  
lamp and backup lamp  
Bulb Mode:P21W(24V21W)、  
P21/5W(24V21/5W)

**3C Authentication**

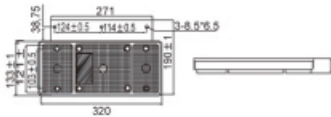

**NG01006 L/R**



**后组合灯 (泡式)**

型号: NG01006  
用途: 具有转向灯/制动灯/后位灯/  
倒车灯的功能  
灯泡型号: P21W(24V21W) × 2、  
P21/5W(24V21/5W)

**3C认证产品**

Tail Lamps  
Type Number:NG01006  
Application:With the functions of the  
turn lamp,stop lamp, rear position  
lamp and backup lamp  
Bulb Mode:P21W(24V21W) × 2、  
P21/5W(24V21/5W)

**3C Authentication**



NG02001



侧标志灯 (泡式)  
侧标志灯支架

型号: NG02001  
用途: 具有侧标志灯/转向灯/  
侧回复反射器的功能

灯泡型号: R5W(24V5W)

3C认证产品

Side Lamps

Type Number:NG02001

Application:With the functions of side

marker lamp and side reflex reflector

Bulb Mode:R5W(24V5W)

3C Authentication

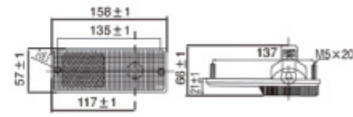

NG02002



侧标志灯 (泡式)  
侧标志灯支架

型号: NG02002  
用途: 具有侧标志灯/侧回复反射器  
的功能

灯泡型号: W5W(24V5W)

3C认证产品

Side Lamps

Type Number:NG02002

Application:With the functions of side

marker lamp and side reflex reflector

Bulb Mode:W5W(24V5W)

3C Authentication

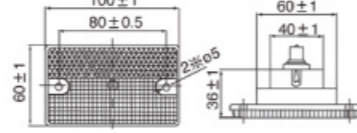

NG02007



侧标志灯 (泡式)

型号: NG02007  
用途: 具有侧标志灯/侧回复反射器  
的功能

灯泡型号: W5W(24V5W)

3C认证产品

Side Lamps

Type Number:NG02007

Application:With the functions of side

marker lamp and side reflex reflector

Bulb Mode:W5W(24V5W)

3C Authentication

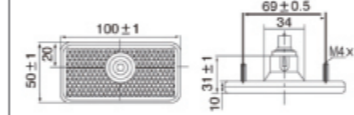

NG02008



侧标志灯 (泡式)  
侧组合灯支架

型号: NG02008  
用途: 具有侧标志灯/侧回复反射器/  
侧转向灯的功能

灯泡型号: P21/5W(24V21/5W)

3C认证产品

Side Lamps

Type Number:NG02008

Application:With the functions of side

marker lamp and side reflex reflector

Bulb Mode:P21/5W(24V21/5W)

3C Authentication

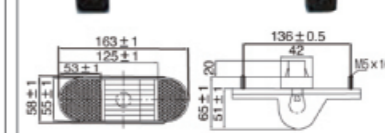

NG02003



侧标志灯 (泡式)  
侧标志灯支架

型号: NG02003  
用途: 具有侧标志灯/侧回复反射器  
的功能

灯泡型号: W5W(24V5W)

3C认证产品

Side Lamps

Type Number:NG02003

Application:With the functions of side

marker lamp and side reflex reflector

Bulb Mode:W5W(24V5W)

3C Authentication

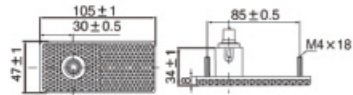

NG02004



侧标志灯 (泡式)

型号: NG02004  
用途: 具有侧标志灯/侧回复反射器  
的功能

灯泡型号: W5W(24V5W)

3C认证产品

Side Lamps

Type Number:NG02004

Application:With the functions of side

marker lamp and side reflex reflector

Bulb Mode:W5W(24V5W)

3C Authentication

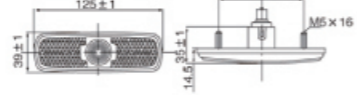

NG02009



侧标志灯 (泡式)

型号: NG02009  
用途: 具有侧标志灯/侧回复反射器  
的功能

灯泡型号: W5W(24V215W)

3C认证产品

Side Lamps

Type Number:NG02009

Application:With the functions of side

marker lamp and side reflex reflector

Bulb Mode:W5W(24V215W)

3C Authentication

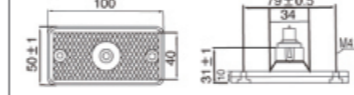

NG02005 L/R

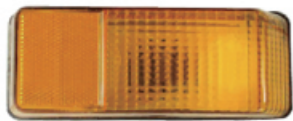

侧标志灯 (泡式)

型号: NG02005 L/R  
用途: 具有侧标志灯/侧转向/侧回复  
反射器的功能

灯泡型号: P21/5W(24V5W)

Side Lamps

Type Number:NG02005 L/R

Application:With the functions of side

marker lamp and side reflex reflector

Bulb Mode:P21/5W(24V5W)

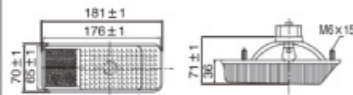

NG02006



侧标志灯 (泡式)

型号: NG02006  
用途: 具有侧标志灯/侧回复反射器  
的功能

灯泡型号: W5W(24V5W)

3C认证产品

Side Lamps

Type Number:NG02006

Application:With the functions of side

marker lamp and side reflex reflector

3C Authentication



NG02010

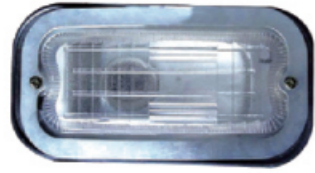

示廓灯

型号: NG02010  
用途: 安装在车辆最外沿和可能靠近最顶部附近, 用来表明车宽和高的灯具。  
灯泡型号: W5W(24V5W)  
Front Rear Outline Marker Lamps/  
Front Position Lamp  
Type Number:NG02010  
Application:Fixed on the vehicle Near The outer aqnd most likely near the top,to show that the height and width of lamps  
Bulb Mode:W5W(24V5W)

NG02011



示廓灯

型号: NG02011  
用途: 安装在车辆最外沿和可能靠近最顶部附近, 用来表明车宽和高的灯具。  
灯泡型号: P21/5W(24V21/5W)  
Front Rear Outline Marker Lamps/  
Front Position Lamp  
Type Number:NG02011  
Application:Fixed on the vehicle Near The outer aqnd most likely near the top,to show that the height and width of lamps  
Bulb Mode:P21/5W(24V21/5W)

NG02012



示廓灯

型号: NG02012  
用途: 安装在车辆最外沿和可能靠近最顶部附近, 用来表明车宽和高的灯具。  
灯泡型号: W5W(24V5W)  
Front Rear Outline Marker Lamps/  
Front Position Lamp  
Type Number:NG02012  
Application:Fixed on the vehicle Near The outer aqnd most likely near the top,to show that the height and width of lamps  
Bulb Mode:W5W(24V5W)

NG03001

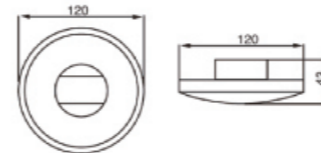

厢式车顶灯 (泡式)

型号: NG03001  
用途: 厢内照明  
灯泡型号: C5W(24V5W)  
Room Lamps  
Type Number:NG03001  
Application:Lighting  
Bulb Mode:C5W(24V5W)

NG03002

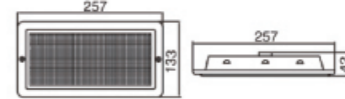

厢式车顶灯 (泡式)

型号: NG03002  
用途: 厢内照明  
灯泡型号: R10W(24V10W\*2)  
Room Lamps  
Type Number:NG03002  
Application:Lighting  
Bulb Mode:R10W(24V10W\*2)

NG03003



厢式车顶灯 (泡式)

型号: NG03003  
用途: 厢内照明  
灯泡型号: R10W(24V10W\*2)  
Room Lamps  
Type Number:NG03003  
Application:Lighting  
Bulb Mode:R10W(24V10W\*2)

NG03004

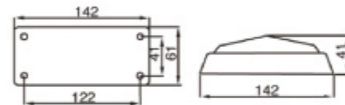

厢式车顶灯 (泡式)

型号: NG03004  
用途: 厢内照明  
灯泡型号: C5W(24V5W)  
Room Lamps  
Type Number:NG03004  
Application:Lighting  
Bulb Mode:C5W(24V5W)

NG03005

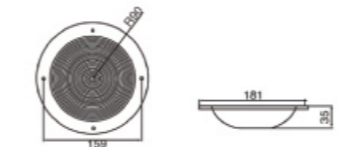

厢式车顶灯 (不锈钢/泡式)

型号: NG03005(原NG03006)  
用途: 厢内照明  
灯泡型号: P21W(24V21W)  
Bulb  
Room Lamp(SUS)  
Type Number:NG03005  
Application:Lighting  
Bulb Mode:P21W(24V21W)

NG03006

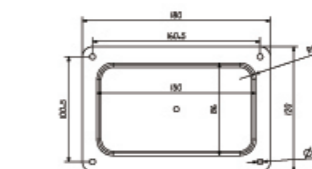

LED不锈钢顶灯

型号: NG03006  
用途: 厢内照明  
电压: 12V/24V  
Bulb & LED  
Type Number:NG03006  
Application:Lighting

NG03007



LED厢式车顶灯 (不锈钢)

型号: NG03007  
用途: 厢内照明  
灯泡型号: P21W(24V21W)  
Bulb&LED  
Room Lamp(SUS)  
Type Number:NG03007  
Application:Lighting  
Bulb Mode:P21W(24V21W)

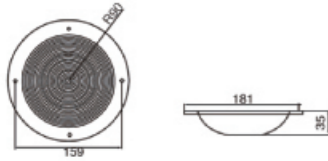

NG09210



LED车厢顶灯

型号: NG09210  
性能: LED具有高亮度、功率低、密封性好、寿命长等特点  
LED数量: 42  
电压: 12V/24V  
Room Lamp(LED)  
Type Number:NG09210  
Description: LED has high brightness,low power,good sealing and long life,100% waterproof  
LED quantity: 42  
Voltage: 12V/24V

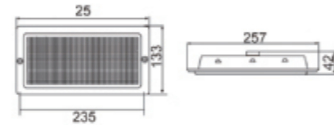

NG04001



前回复反射器

型号: NG04001  
用途: 通过外来光源照射,反射光向位于光源附近的观察者,表明车辆存在的位置。  
3C认证产品  
Front Reflex Reflector  
Type Number:NG04001  
Appliction: By external radiation light source,the relected light to the light source in the vicinity of observer, showed that the locaation of vehicles  
3C Authentication

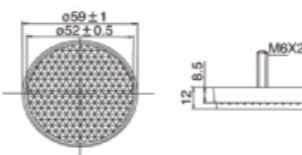

NG04002



三角后回复反射器

型号: NG04002(三孔)  
用途: 通过外来光源照射,反射光向位于光源附近的观察者,表明车辆存在的位置。  
3C认证产品  
WARING TRIANGLE  
Type Number:NG04002  
Appliction: By external radiation light source,the relected light to the light source in the vicinity of observer, showed that the locaation of vehicles  
3C Authentication

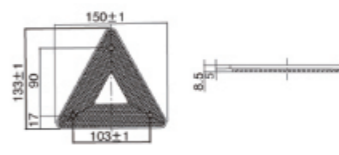

NG09211



车厢顶灯LED(可带开关)

型号: NG09211  
性能: LED具有高亮度、功率低、密封性好、寿命长等特点  
LED数量: 18/18  
电压: 12V/24V  
Room Lamp(LED)  
Type Number:NG09211  
Description: LED has high brightness,low power,good sealing and long life,100% waterproof  
LED quantity: 18/18  
Voltage: 12V/24V

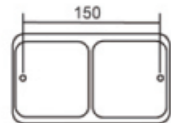

NG04003



三角后回复反射器

型号: NG04003(二孔)  
用途: 通过外来光源照射,反射光向位于光源附近的观察者,表明车辆存在的位置。  
WARING TRIANGLE  
Type Number:NG04003  
Appliction: By external radiation light source,the relected light to the light source in the vicinity of observer, showed that the locaation of vehicles

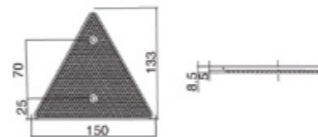

NG04005



侧回复反射器

型号: NG04005  
用途: 通过外来光源照射,反射光向位于光源附近的观察者,表明车辆存在的位置。  
3C认证产品  
Side Reflex Reflector  
Type Number:NG04005  
Appliction: By external radiation light source,the relected light to the light source in the vicinity of observer, showed that the locaation of vehicles  
3C Authentication

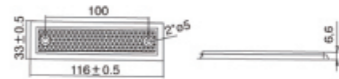

NG04007



侧回复反射器

型号: NG04007  
规格:150\*25mm  
用途: 通过外来光源照射,反射光向位于光源附近的观察者,表明车辆存在的位置。  
3C认证产品  
Side Reflex Reflector  
Type Number:NG04011  
Appliction:By external radiation light source,the relected light to the light source in the vicinity of observer, showed that the location of vehicles  
3C Authentication

NG04008

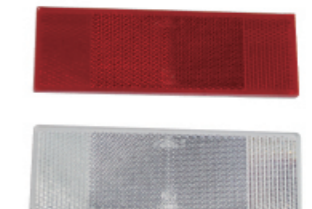

侧回复反射器

型号: NG04008  
用途: 通过外来光源照射,反射光向位于光源附近的观察者,表明车辆存在的位置。  
3C认证产品  
Side Reflex Reflector  
Type Number:NG04008  
Appliction: By external radiation light source,the relected light to the light source in the vicinity of observer, showed that the locaation of vehicles  
3C Authentication



NG04009

尾部标志板

产品规格:565\*200 ± 10(mm)  
1130\*200 ± 10(mm)

产品说明:红色边框宽度为40mm  
红色荧光膜边框,黄色为反光材料  
适用车型:长型、重型车辆(如挂车  
或半挂车)

3C认证产品  
具备检测报告

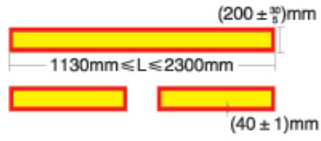

黄色回复  
反射材料  
红色荧光材料或  
回复反射材料

NG04010

尾部标志板

产品规格:565\*140 ± 10(mm)  
1130\*140 ± 10(mm)

条纹规格:142\*100mm

产品说明:斜向条纹45° 红色均为  
反光材料

适用车型:长型、重型车辆

3C认证产品  
具备检测报告

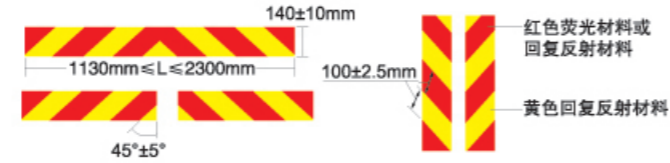

红色荧光材料或  
回复反射材料  
黄色回复反射材料

NG04012

尾部标志板

产品规格:565\*135(mm)  
条纹规格:142\*100mm

产品说明:  
1-红色回复材料或直角型回复反射器  
(1类或2类);  
2-红色荧光材料(1类)或回复反射  
材料(2类)。

适用车型:低速车辆(如火车或牵引车)

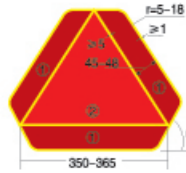

NG04013

反射器

型号: NG04013  
规格: 宽\*长

5\*90cm

10\*90cm

15\*90cm

条纹规格: 40\*120cm

50\*140cm

60\*160cm

产品说明:由多个方向性微晶立体  
组成的全新反射系统,比普通发光  
喷绘布更具广角性,并且有闪烁效  
果。



NG05002

轮胎挡泥罩

型号: NG05002  
尺寸: 跨度 × 宽度 × 高度

1270 × 630 × 600

弧长/Arc Length: 1930

重量/Weight : 5.5Kg

Tire Mud Guard

Type Number:NG05002

Measurement:

Span × Width × Height

1300 × 650 × 580

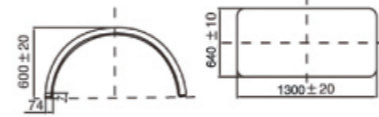
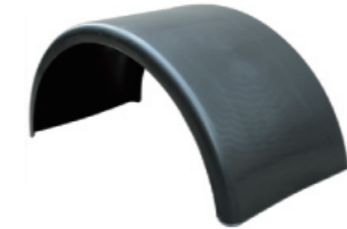

NG05001

轮胎挡泥罩

型号: NG05001  
尺寸: 跨度 × 宽度 × 高度

1320 × 640 × 660

弧长/Arc Length: 2090

重量/Weight : 6.6Kg

Tire Mud Guard

Type Number:NG05001

Measurement:

Span × Width × Height

1320 × 640 × 660

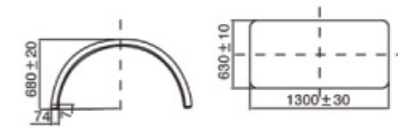

挡泥罩组件

轮胎挡泥罩组件

1.轮胎挡泥罩

2.挡泥罩调节压板

3.挡泥罩支架直管

4.挡泥皮

5.挡泥罩支架弯管

Tire Mud Guare Assembly

1.Tire Mud Guard

2.Adjusting Clamp

3.Mud Guard Bracket

4.Mud Guard Flat

5.Stent Band Tube

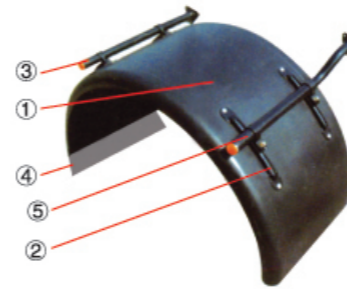

NG05003

分体式挡泥罩

型号: NG05003  
尺寸: 长度 × 宽度

645 × 645

管夹: Φ38 Φ42

弧长/Arc Length: 700

重量/Weight : 1.3Kg

带滑块 1.75Kg

Detachable Tire Mud Guard

Type Number:NG05003

Measurement:

Length × Width

645 × 645

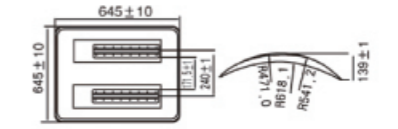

NG05004

分体式挡泥罩

型号: NG05004

尺寸: 长度 × 宽度

645 × 500

管夹: Φ38 Φ42

弧长/Arc Length: 700

重量/Weight : 1.3Kg

带滑块 1.3Kg

Detachable Tire Mud Guard

Type Number:NG05004

Measurement:

Length × Width

645 × 500



NG05005

轮胎挡泥罩

型号: NG05005

尺寸: 长度 × 宽度 × 高度

960 × 465 × 480

弧长/Arc Length: 1500

重量/Weight : 3.15Kg

Tire Mud Guard

Type Number:NG05005

Measurement:

Span × Width × Height

960 × 465 × 480

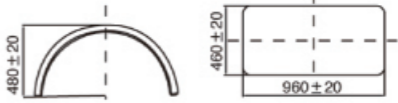

NG05006



轮胎挡泥罩

型号: NG05006  
尺寸: 跨度 × 宽度 × 高度  
1270 × 490 × 640  
弧长/Arc Length: 1950  
重量/Weight: 4.4Kg  
Tire Mud Guard  
Type Number: NG05006  
Measurement:  
Span × Width × Height  
1270 × 490 × 640

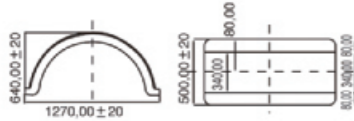

NG05007



轮胎挡泥罩(加强型)

型号: NG05007  
尺寸: 跨度 × 宽度 × 高度  
1270 × 630 × 600  
弧长/Arc Length: 1950  
重量/Weight: 6.35Kg  
功能: 挡泥罩采用凹凸加强设计, 具有硬度强, 美观防止雨水飞溅, 导流作用。  
Tire Mud Guard (Strengthened)  
Type Number: NG05007  
Measurement:  
Span × Width × Height  
1270 × 630 × 600  
Mud guard is adopted to use the strengthened concave design with the strong hardness, aesthetic preventing from splashing water, and diversion effects

NG05007-1



轮胎挡泥罩(加强型)

型号: NG05007-1  
尺寸: 跨度 × 宽度 × 高度  
1270 × 665 × 610  
弧长/Arc Length: 1950  
重量/Weight: 6.35Kg  
功能: 挡泥罩采用凹凸加强设计, 具有硬度强, 美观防止雨水飞溅, 导流作用(滑槽/白边颜色可任选)  
Tire Mud Guard (Strengthened)  
Type Number: NG05007-1  
Measurement:  
Span × Width × Height  
1270 × 665 × 610  
Mud guard is adopted to use the strengthened concave design with the strong hardness, aesthetic preventing from splashing water, and diversion effects

NG05008



轮胎挡泥罩(加强型)

型号: NG05008  
尺寸: 跨度 × 宽度 × 高度  
1300 × 650 × 680  
弧长/Arc Length: 2050  
重量/Weight: 6.85Kg  
功能: 挡泥罩采用凹凸加强设计, 具有硬度强, 美观防止雨水飞溅, 导流作用。  
Tire Mud Guard  
Type Number: NG05008  
Measurement:  
Span × Width × Height  
1300 × 650 × 680  
Mud guard is adopted to use the strengthened concave design with the strong hardness, aesthetic preventing from splashing water, and diversion effects

NG05008-1

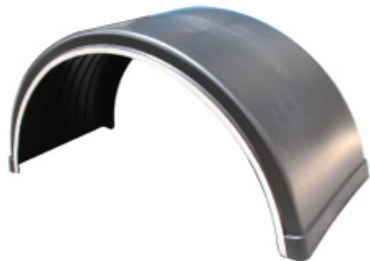

轮胎挡泥罩

型号: NG05008-1  
尺寸: 跨度 × 宽度 × 高度  
1300 × 650 × 680  
弧长/Arc Length: 2100  
重量/Weight: 6.3Kg  
Tire Mud Guard  
Type Number: NG05008-1  
Measurement:  
Span × Width × Height  
1300 × 650 × 680



NG05009



挡泥罩

型号: NG05009  
尺寸: 跨度 × 宽度 × 高度  
1270 × 630 × 590  
弧长/Arc Length: 2100  
重量/Weight: 6.05Kg  
Tire Mud Guard  
Type Number: NG05009  
Measurement:  
Span × Width × Height  
1270 × 630 × 590

NG05015



双轴轮胎挡泥罩(不锈钢)

型号: NG05015  
尺寸: 长度 × 宽度 × 高度  
2660 × 620 × 600  
弧长/Arc Length: 3330  
重量/Weight: 28.5Kg  
Tire Mud Guard  
Type Number: NG05015  
Measurement:  
Span × Width × Height  
2660 × 620 × 600  
备注: 跨度和高度可根据客户需求定制

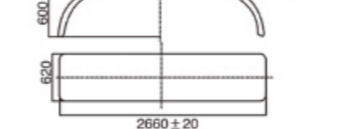

NG05016

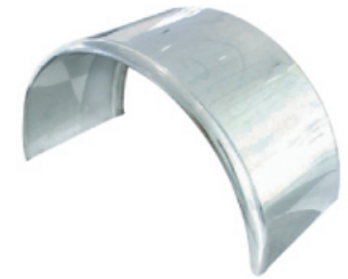

轮胎挡泥罩(不锈钢)

型号: NG05016  
尺寸: 跨度 × 宽度 × 高度  
1270 × 620 × 630  
弧长/Arc Length: 1950  
重量/Weight: 15.45Kg  
Tire Mud Guard  
Type Number: NG05016  
Measurement:  
Span × Width × Height  
1270 × 620 × 630

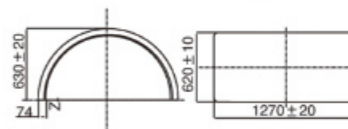

NG05017

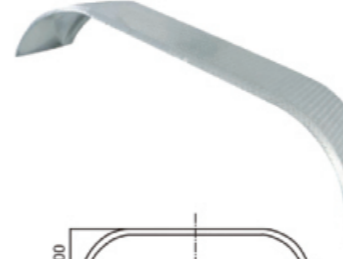

双轴轮胎挡泥罩(铝合金)

型号: NG05017  
尺寸: 跨度 × 宽度 × 高度  
2660 × 620 × 600  
弧长/Arc Length: 3330  
重量/Weight: 18.3Kg  
Tire Mud Guard  
Type Number: NG05017  
Measurement:  
Span × Width × Height  
2660 × 620 × 600  
备注: 跨度和高度可根据客户需求定制

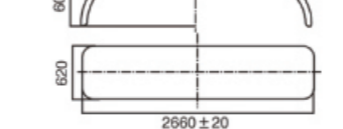

NG05018

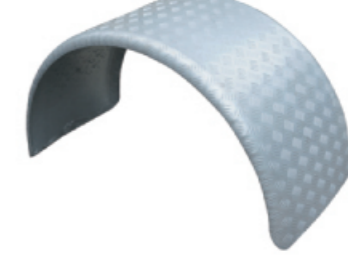

轮胎挡泥罩(铝合金)

型号: NG05018  
尺寸: 跨度 × 宽度 × 高度  
1270 × 620 × 630  
弧长/Arc Length: 1950  
重量/Weight: 10.85Kg  
Tire Mud Guard  
Type Number: NG05018  
Measurement:  
Span × Width × Height  
1270 × 620 × 630



NG05019



分体式挡泥罩(铝合金)

型号: NG05019  
尺寸: 跨度 × 宽度 × 高度  
680 × 610 × 110  
弧长/Arc Length: 660  
重量/Weight: 3.1Kg  
Split Mud Guard  
Type Number: NG05019  
Measurement:  
Span × Width × Height  
680 × 610 × 110

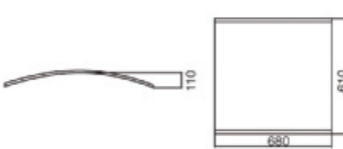

NG05026



挡泥罩

型号: NG05026  
尺寸: 长度 × 宽度 × 高度  
660 × 200 × 325  
弧长/Arc Length: 1070  
重量/Weight: 1.1Kg  
Tire Mud Guard  
Type Number: NG05026  
Measurement:  
Span × Width × Height  
660 × 200 × 325

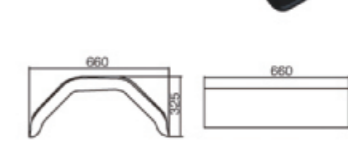

NG05027



挡泥罩

型号: NG05027  
尺寸: 长度 × 宽度 × 高度  
770 × 220 × 325  
弧长/Arc Length: 1130  
重量/Weight: 1.1Kg  
Tire Mud Guard  
Type Number: NG05027  
Measurement:  
Span × Width × Height  
770 × 220 × 325



NG05028



挡泥罩

型号: NG05028  
尺寸: 跨度 × 宽度 × 高度  
1660 × 240 × 385  
弧长/Arc Length: 2030  
重量/Weight: 3.45Kg  
Tire Mud Guard  
Type Number: NG05028  
Measurement:  
Span × Width × Height  
1660 × 240 × 385

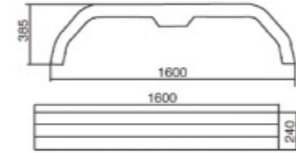

NG05071



轮胎挡泥罩(铁)

型号: NG05071  
尺寸: 长度 × 宽度 × 高度  
1250 × 620 × 600  
弧长/Arc Length: 1950  
重量/Weight: 17Kg  
Split Mud Guard  
Type Number: NG05071  
Measurement:  
Span × Width × Height  
1250 × 620 × 600  
备注: 跨度和高度可根据  
客户需求定制

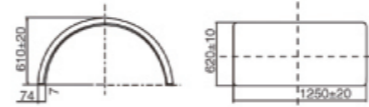

NG05072



双轴轮胎挡泥罩(铁)

型号: NG05072  
尺寸: 跨度 × 宽度 × 高度  
2660 × 620 × 600  
弧长/Arc Length: 3330  
重量/Weight: 27Kg  
Tire Mud Guard  
Type Number: NG05072  
Measurement:  
Span × Width × Height  
2660 × 620 × 600  
备注: 跨度和高度可根据  
客户需求定制

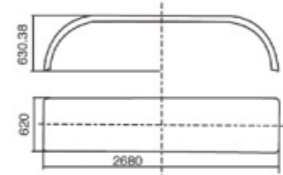

NG05029



挡泥罩

型号: NG05029  
尺寸: 跨度 × 宽度 × 高度  
590 × 180 × 160  
弧长/Arc Length: 660  
重量/Weight: 0.6Kg  
Tire Mud Guard  
Type Number: NG05029  
Measurement:  
Span × Width × Height  
590 × 180 × 160

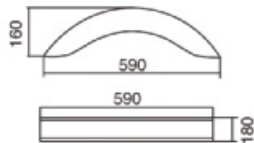

NG05068



分体式挡泥罩(不锈钢)

型号: NG05068  
尺寸: 跨度 × 宽度 × 高度  
1010 × 620 × 220  
弧长/Arc Length: 1160  
重量/Weight: 8.6Kg  
Split Mud Guard  
Type Number: NG05068  
Measurement:  
Span × Width × Height  
1010 × 620 × 220  
备注: 跨度和高度可根据  
客户需求定制

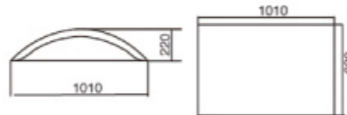

NG05073



三桥轮胎挡泥罩(铁)

型号: NG05073  
尺寸: 跨度 × 宽度 × 高度  
4010 × 620 × 600  
弧长/Arc Length: 4700  
重量/Weight: 37Kg  
Tire Mud Guard  
Type Number: NG05073  
Measurement:  
Span × Width × Height  
4010 × 620 × 600  
备注: 跨度和高度可根据  
客户需求定制

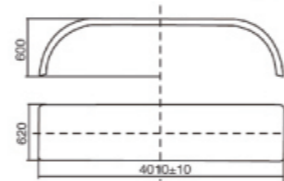

NG05074

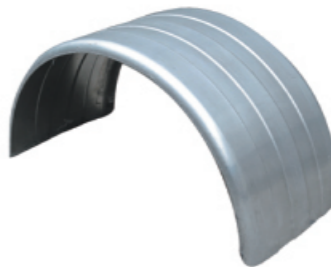

轮胎挡泥罩(铁/加强型)

型号: NG05074  
尺寸: 跨度 × 宽度 × 高度  
1250 × 485 × 600 重量/Weight: 11Kg  
1250 × 620 × 600 重量/Weight: 16Kg  
1250 × 660 × 600 重量/Weight: 17Kg  
弧长/Arc Length: 1950  
Type Number: NG05074  
Mud guard is adopted to use the  
strengthened concaveconvex design,  
with the strong  
hardness, aesthetic, preventing  
from splashing water and  
deformation effects  
备注: 跨度和高度可根据  
客户需求定制



NG05069



分体式挡泥罩(铝合金)

型号: NG05069  
尺寸: 跨度 × 宽度 × 高度  
950 × 620 × 220  
弧长/Arc Length: 1060  
重量/Weight: 5.45Kg  
Split Mud Guard  
Type Number: NG05069  
Measurement:  
Span × Width × Height  
950 × 620 × 220  
备注: 跨度和高度可根据  
客户需求定制

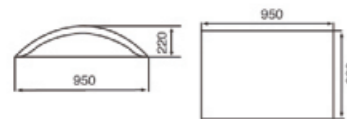

NG05070

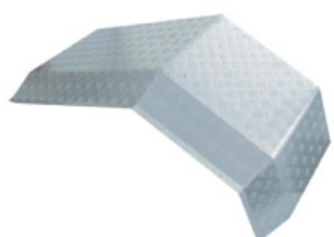

整体式挡泥罩(铝合金)

型号: NG05070  
弧长/Arc Length: 1850  
重量/Weight: 11.11Kg  
Split Mud Guard  
Type Number: NG05070  
备注: 跨度和高度可根据  
客户需求定制

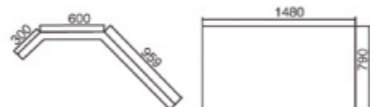

NG05075



双轴轮胎挡泥罩(铁/加强型)

型号: NG05075  
尺寸: 跨度 × 宽度 × 高度  
2660 × 485 × 600  
重量/Weight: 21Kg  
2660 × 620 × 600  
重量/Weight: 27Kg  
2660 × 660 × 600  
重量/Weight: 28Kg  
弧长/Arc Length: 3400  
Type Number: NG05075  
备注: 跨度和高度可根据  
客户需求定制

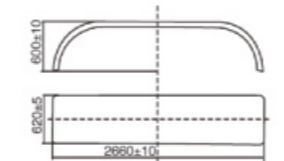

NG05076

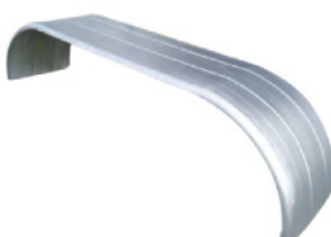

三轴轮胎挡泥罩(铁/加强型)

型号: NG05076  
尺寸: 跨度 × 宽度 × 高度  
4010 × 485 × 600  
重量/Weight: 29Kg  
4010 × 620 × 600  
重量/Weight: 37Kg  
4010 × 660 × 600  
重量/Weight: 38Kg  
弧长/Arc Length: 4700  
Tire Mud Guard  
Type Number: NG05076  
备注: 跨度和高度可根据  
客户需求定制

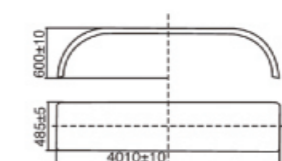

NG05077



**轮胎挡泥罩(铁)**  
型号: NG05077  
尺寸: 长度×宽度×高度  
1250×485×600  
重量/Weight: 12Kg  
1250×660×600  
重量/Weight: 17Kg  
弧长/Arc Length: 1950  
Tire Mud Guard  
Type Number:NG05077

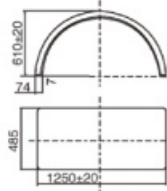

NG05078



**双轴轮胎挡泥罩(铁/加强型)**  
型号: NG05078  
尺寸: 跨度×宽度×高度  
2660×485×600  
重量/Weight: 22Kg  
2660×660×600  
重量/Weight: 29Kg  
弧长/Arc Length: 3330  
Tire Mud Guard  
Type Number:NG05078

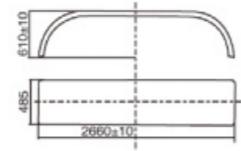

NG05083



**轮胎挡泥罩**  
型号: NG05083  
尺寸: 长度×宽度×高度  
930×235×300  
弧长/Arc Length: 1260  
重量/Weight :2Kg  
Split Mud Guard  
Type Number:NG05083  
Measurement:  
Span×Width×Height  
930×235×300

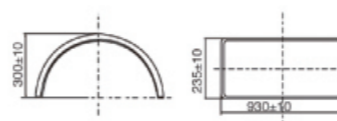

NG05084



**轮胎挡泥罩**  
型号: NG05084  
尺寸: 跨度×宽度×高度  
780×220×385  
弧长/Arc Length: 1150  
重量/Weight: 1.8Kg  
Split Mud Guard  
Type Number:NG05084  
Measurement:  
Span×Width×Height  
780×220×385

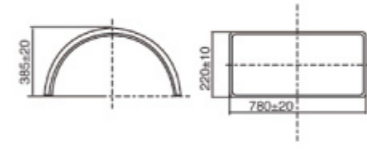

NG05079



**三轴轮胎挡泥罩(铁/加强型)**  
型号: NG05079  
尺寸: 跨度×宽度×高度  
4010×485×600  
重量/Weight: 32Kg  
4010×660×600  
重量/Weight: 38Kg  
弧长/Arc Length: 4700  
Tire Mud Guard  
Type Number:NG05079

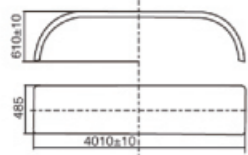

NG05080



**轮胎挡泥罩(铝合金/加强型)**  
型号: NG05080  
尺寸: 跨度×宽度×高度  
1250×485×600 重量/Weight: 5Kg  
1250×620×600 重量/Weight: 6Kg  
1250×660×600 重量/Weight: 6.5Kg  
弧长/Arc Length: 1950  
功能: 挡泥罩采用凹凸加强设计, 具有硬度强, 美观防止雨水飞溅, 导流作用。  
Tire Mud Guard(Stredgthen)  
Type Number:NG05080  
Mud guard is adopted to use the strengthe concaveconvex design, with the strong hardness,aesthetic, preventing from splashing water and diversion effects  
备注: 跨度和高度可根据客户需求定制

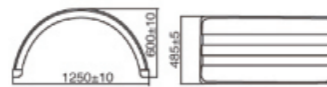

NG05101



**轮胎挡泥罩**  
型号: NG05101  
尺寸: 跨度×宽度×高度  
1270×680×680  
弧长/Arc Length: 2070  
重量/Weight: 6.65Kg  
Split Mud Guard  
Type Number:NG05101  
Measurement:  
Span×Width×Height  
1270×680×680  
Apply to the specification of  
1200\1100 and 1000 tires

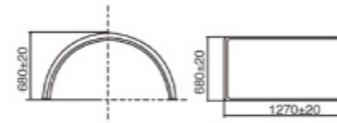

NG05102



**轮胎挡泥罩**  
型号: NG05102  
尺寸: 长度×宽度×高度  
1270×460×680  
弧长/Arc Length: 2020  
重量/Weight :4.75Kg  
Split Mud Guard  
Type Number:NG05102  
Measurement:  
Span×Width×Height  
1270×460×680

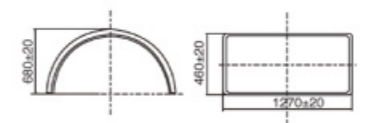

NG05081

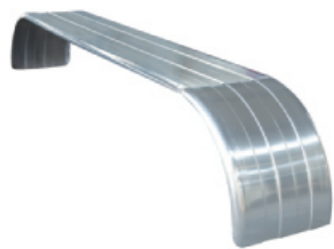

**双轮轴挡泥罩(铝合金/加强型)**  
型号: NG05081  
尺寸: 跨度×宽度×高度  
2660×485×600 重量/Weight: 9Kg  
2660×620×600 重量/Weight: 11Kg  
2660×660×600 重量/Weight: 16Kg  
弧长/Arc Length: 3400  
Tire Mud Guard  
Type Number:NG05081  
备注: 跨度和高度可根据客户需求定制

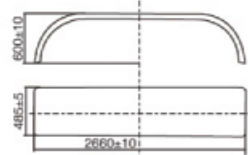

NG05082

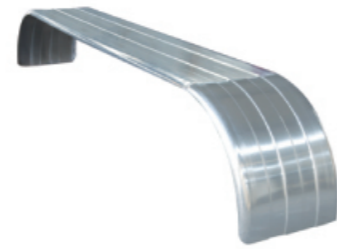

**三轮轴挡泥罩(铝合金/加强型)**  
型号: NG05082  
4010×485×600 重量/Weight: 12Kg  
4010×620×600 重量/Weight: 15Kg  
4010×660×600 重量/Weight: 16Kg  
弧长/Arc Length: 4700  
Tire Mud Guard  
Split Mud Guard  
Type Number:NG05082  
备注: 跨度和高度可根据客户需求定制

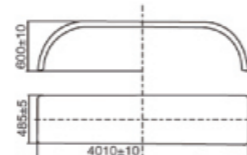

NG05103



**轮胎挡泥罩**  
型号: NG05103  
尺寸: 长度×宽度×高度  
1300×630×620  
弧长/Arc Length: 2000  
重量/Weight :6.75Kg  
Tire Mud Guard  
Type Number:NG05103  
Measurement:  
Span×Width×Height  
1300×630×620

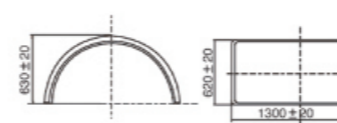

NG05104



**轮胎挡泥罩**  
型号: NG05104  
尺寸: 长度×宽度×高度  
1500×640×700  
弧长/Arc Length: 2100  
重量/Weight :7Kg  
Tire Mud Guard  
Type Number:NG05104  
Measurement:  
Span×Width×Height  
1500×640×700



NG05105

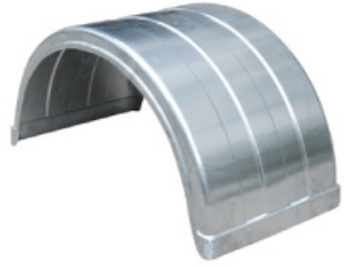

轮胎挡泥罩(铝合金/加强型)

型号: NG05105  
尺寸: 长度×宽度×高度  
1250×485×600  
1250×660×600  
Tire Mud Guard(Strengthen)  
Type Number: NG05105  
Mud guard is adopted to use the strength concaveconvex design with the strong hardness, aesthetic, preventing from splashing water and diversion effects



NG05106

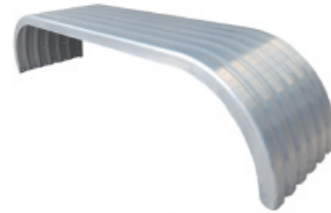

轮胎挡泥罩(铝合金)

型号: NG05106  
尺寸: 跨度×宽度×高度  
2800×700×630  
弧长/Arc Length: 2020  
Split Mud Guard  
Type Number: NG05106  
Measurement:  
Span×Width×Height  
2800×700×630

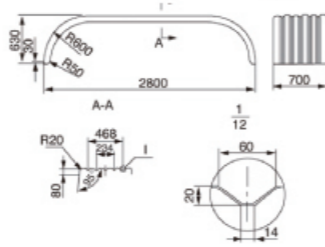

NG05020

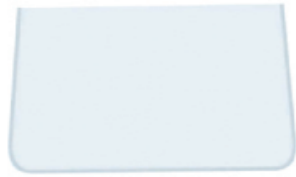

轮胎挡泥皮

型号: NG05020  
描述: 采用PVC板材加工, 可采用PE材料, 耐高温、低温。  
Tire Mud Flat  
Type Number: NG05020  
Description: Using the PVC sheet processing

NG05021



轮胎挡泥皮

型号: NG05021  
描述: 采用橡胶材质模具一次性注塑而成  
Tire Mud Flat  
Type Bumper: NG05021  
Description: Using a rubber material mold from injection

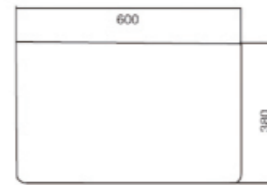

NG05022



轮胎挡泥皮

型号: NG05022  
描述: 采用橡胶材质模具一次性注塑而成  
Tire Mud Flat  
Type Bumper: NG05022  
Description: Using a rubber material mold from injection

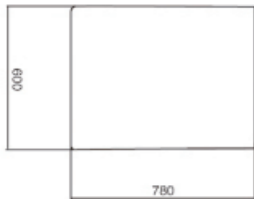

NG05107 双轴双胎挡泥罩(塑料)

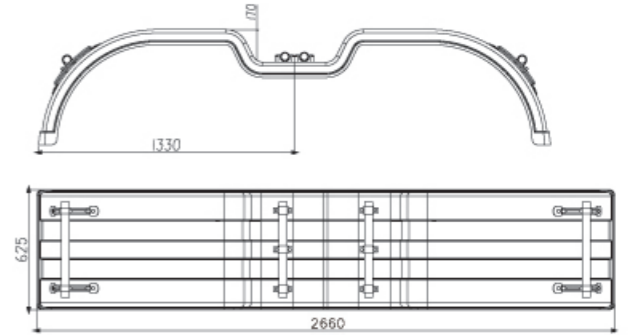

NG05108 三轴双胎挡泥罩(塑料)

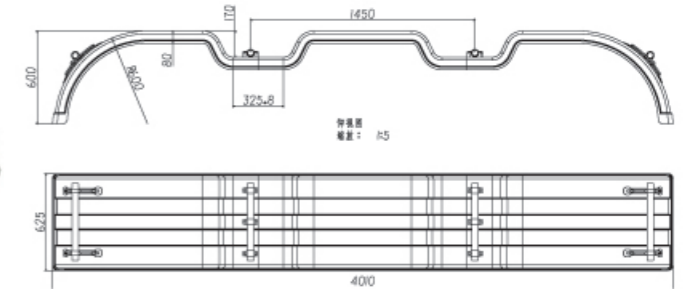

NG05107-1 双轴双胎挡泥罩(铁)



安装效果

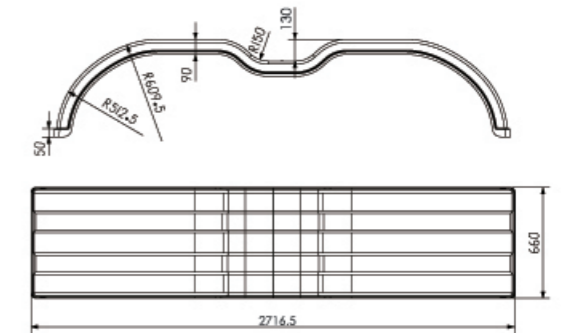

NG05108-1 三轴双胎挡泥罩(铁)



安装效果

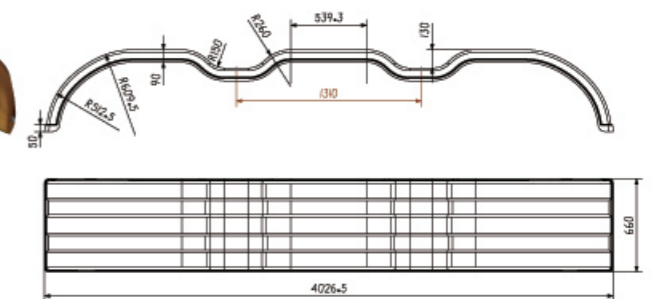

**NG05010**



**挡泥罩支架(直管)**

型号: NG05010(锌Φ42/38)  
NG05010(黑Φ42/38)  
用途: 连接挡泥罩和压板  
Bracket(Strent Tube)Iron  
Type Number:  
NG05010(galvanizing)  
NG05010(painting)  
Application:Connecting to the  
mud guard and clamp

**NG05011**



**挡泥罩支架(弯管/铁)**

型号: NG05011(锌Φ42/38)  
NG05011(黑Φ42/38)  
用途: 连接挡泥罩和压板,  
可调节角度。  
Bracket(Strent Tube)Iron  
Type Number:  
NG05011(galvanizing)  
NG05011(painting)  
Application:Connecting to the  
mud guard and clamp it can  
adjust the angles



**NG045010**



**挡泥罩调节压板**

材料: 钢  
重量: 0.58kg  
表面处理: 镀锌  
Material:steel  
Weight:0.58kg  
Finish:zinc

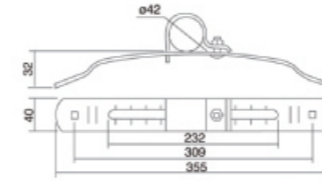

**NG045030**



**挡泥罩调节压板**

材料: 钢  
重量: 0.24kg  
表面处理: 镀锌  
Material:steel  
Weight:0.24kg  
Finish:zinc

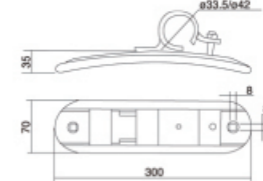

**NG05011-1**



**挡泥罩支架(铁)**

型号: NG05011-1(锌Φ42/38)  
用途: 连接挡泥罩和压板。  
Bracket(Strent Tube)Iron  
Type Number:  
NG05011-1(galvanizing)  
Application:Connecting to the  
mud guard and clamp it can  
adjust the angles

**NG05012**



**挡泥罩上下压板(铁)**

型号: NG05012(黑)  
适用于支架与挡泥罩之间的连接  
UL Clamp(Iron)  
Type Number:  
NG05012(painting)  
Using to connect between  
bracketand mud guard

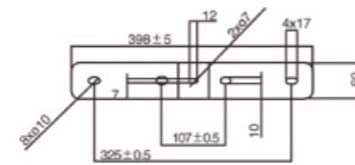

**NG045040**



**挡泥罩调节压板**

材料: 钢  
重量: 0.22kg  
表面处理: 镀锌  
Material:steel  
Weight:0.22kg  
Finish:zinc

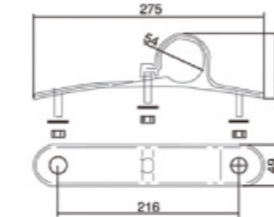

**NG045050**



**挡泥罩调节压板**

材料: 钢  
表面处理: 镀锌  
Material:steel  
Finish:zinc

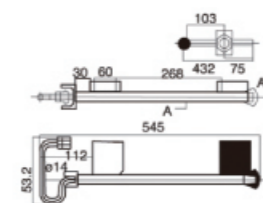

**NG05013**



**挡泥罩调节压板(铁)**

型号: NG05013(镀锌)  
NG05013(喷漆)  
适用于支架与挡泥罩之间的连接  
可以根据高度上下调整  
Adjusting Ciamp(Iron)  
Type Number:  
NG05013(galvanizing)  
NG05013(painting)  
Using to connect between  
bracketand mud guard it can be  
adjusted to the height from top  
to botten

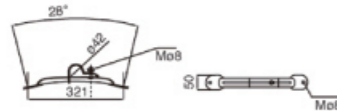

**NG05014**



**挡泥罩支架(铁)**

型号: NG05014(锌Φ42/38)  
用途: 连接挡泥罩和压板, 可调节  
角度  
Bracket(Strent Tube)Iron  
Type Number:  
NG05014(galvanizing)  
Application:Connecting to the  
mud guard and clamp it can  
adjust the angle

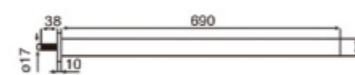

**NG045060**



**挡泥罩调节压板**

材料: 钢  
重量: 0.8kg  
表面处理: 镀锌  
Material:steel  
Weight:0.8kg  
Finish:zinc

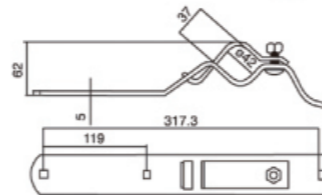

**NG045100**



**挡泥罩支架**

材料: 钢  
重量: 2.0kg  
表面处理: 镀锌  
Material:steel  
Weight:2.0kg  
Finish:zinc

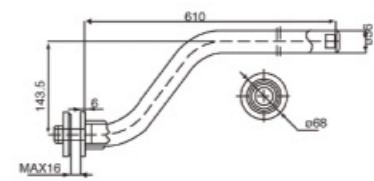

NG15001

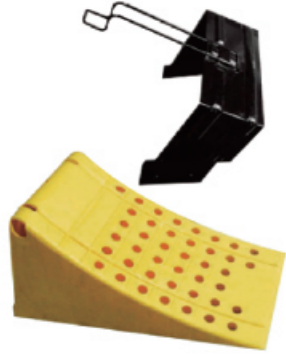

挡车器

型号: NG15001  
描述: 适用于车辆维修停在下坡或上坡时放于车轮下装置。  
Blocking Device  
Type Number: NG15001  
Description: Suitale for vehicle repair stop in the downhill, uphill for blocking the wheel of the device



NG15002



挡车器

型号: NG15002  
描述: 适用于车辆维修停在下坡或上坡时放于车轮下装置。  
Blocking Device  
Type Number: NG15002  
Description: Suitale for vehicle repair stop in the downhill, uphill for blocking the wheel of the device



NG15003

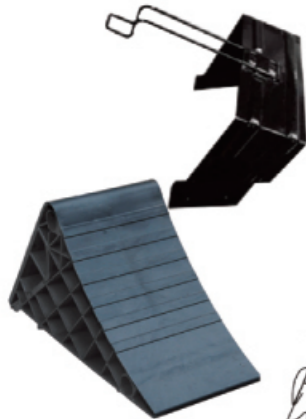

挡车器

型号: NG15003  
描述: 适用于车辆维修停在下坡或上坡时放于车轮下装置。  
Blocking Device  
Type Number: NG15003  
Description: Suitale for vehicle repair stop in the downhill, uphill for blocking the wheel of the device

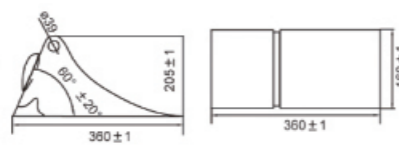

NG15004



挡车器

型号: NG15004  
描述: 适用于车辆维修停在下坡或上坡时放于车轮下装置。  
Blocking Device  
Type Number: NG15004  
Description: Suitale for vehicle repair stop in the downhill, uphill for blocking the wheel of the device

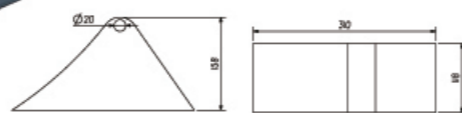

NG15005



挡车器

型号: NG15005  
描述: 适用于车辆维修停在下坡或上坡时放于车轮下装置。  
Blocking Device  
Type Number: NG15005  
Description: Suitale for vehicle repair stop in the downhill, uphill for blocking the wheel of the device

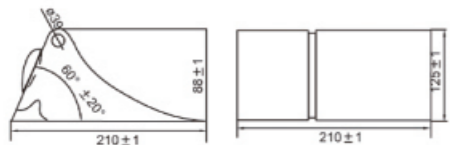

NG15006



挡车器

型号: NG15006(085100)  
描述: 适用于车辆维修停在下坡或上坡时放于车轮下装置。  
Blocking Device  
Type Number: NG15004(085100)  
Description: Suitale for vehicle repair stop in the downhill, uphill for blocking the wheel of the device

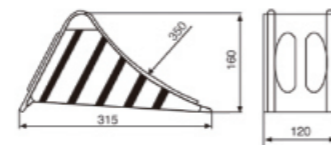

NG61022F/R



不锈钢轮罩

高级22.5"通用Universal  
侧孔10 Hand Holes  
中心距 PCD:  $\Phi 285.75/335.0$   
适用车型 Applicable Modles  
All Truck&Bus

NG61622S



不锈钢轮罩

高级22.5"  
Wheel stud Protector Disc  
侧孔10 Hand Holes  
中心距 PCD:  $\Phi 335.0/285.0$   
适用车型 Applicable Modles  
All Truck&Bus

NG62017F/R



不锈钢轮罩

17.5"通用Universal  
螺母6 Lugnuts  
侧孔6 Hand Holes  
中心距 PCD:  $\Phi 205/222.25$   
适用车型 Applicable Modles  
Daewoo Eurocargo ISUZU Lveco  
BENZ Renault All Truck&Bus

NG71610F/R



不锈钢轮罩

16"通用Universal  
螺母6 Lugnuts  
侧孔6 Hand Holes  
中心距 PCD:  $\Phi 222.25$   
适用车型 Applicable Modles  
宇通、金龙、江淮、本田  
Coaster V-star

NG71612R/F



不锈钢轮罩

16"通用Universal  
螺母6 Lugnuts  
侧孔6 Hand Holes  
中心距 PCD:  $\Phi 203/205$   
适用车型 Applicable Modles  
宇通、金龙、江淮、本田  
Coaster V-star

NG72204F



不锈钢轮罩

豪华22.5"通用Universal  
螺母10 Lugnuts  
侧孔10 Hand Holes  
中心距 PCD:  $\Phi 335.0$   
适用车型 Applicable Modles  
Benz ISUZU Neoplan MAN  
GM  
Volvo All Truck&Bus  
22.5\*8.25\*9.0"

NG72207F/R



**不锈钢轮罩**  
豪华22.5"通用Universal  
螺母10 Lugnuts  
侧孔10 Hand Holes  
中心距 PCD:  $\Phi 287.75/335.0$   
适用车型 Applicable Modles  
All Truck&Bus  
22.5\*7.5"/8.25\*9.0

NG05061

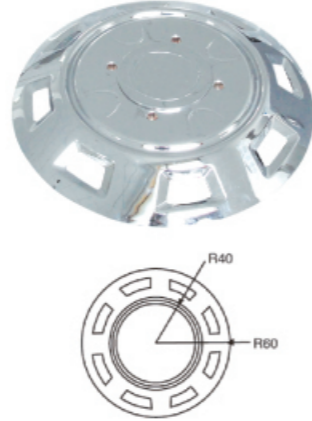

**轮胎帽(前轮)**  
型号: NG05061  
尺寸:  $\Phi 60$   
Tire Cap(Front Wheel)  
Type Number: N:05061  
Measurement:  $\Phi 60$

NG05062

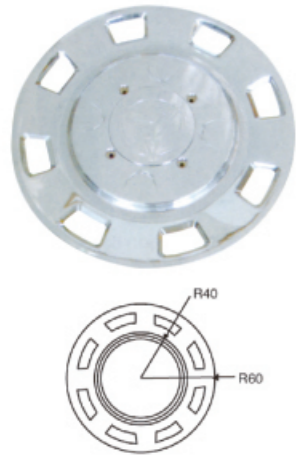

**轮胎帽(后轮)**  
型号: NG05062  
尺寸:  $\Phi 60$   
Tire Cap(Rear Wheel)  
Type Number: N:05062  
Measurement:  $\Phi 60$

NG05063

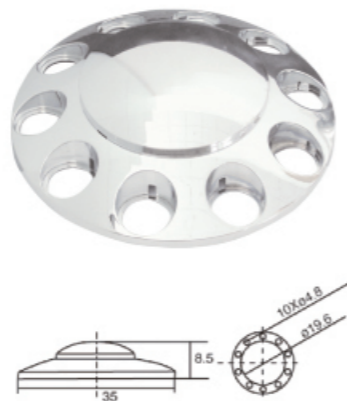

**矮轮罩(圆)**  
型号: NG05063  
Short Wheel Cover(Round)  
Type Number: NG05063

NG05064

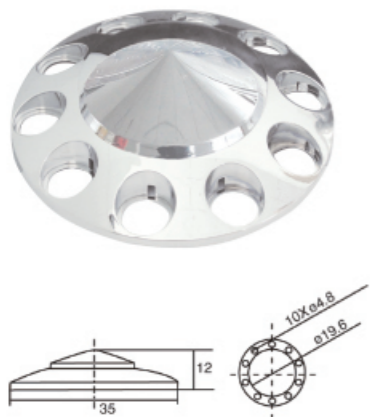

**矮轮罩(尖)**  
型号: NG05064  
Short Wheel Cover(TiPl)  
Type Number: NG05064

NG05065

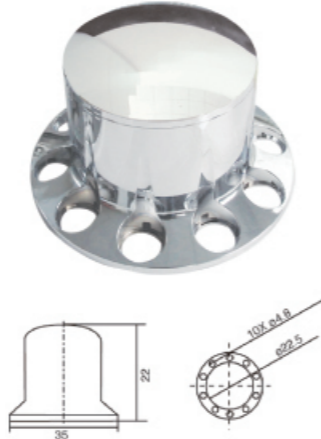

**高轮罩(圆)**  
型号: NG05065  
Wheel Cover(Round)  
Type Number: NG05065

NG05066

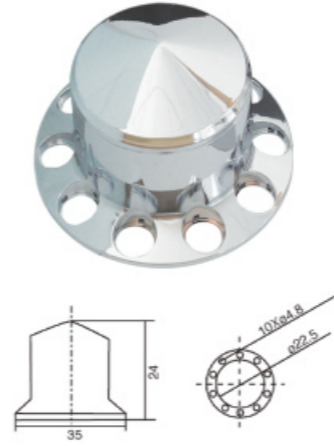

**高轮罩(尖)**  
型号: NG05066  
Wheel Cover(TiPl)  
Type Number: NG05066

NG61622S

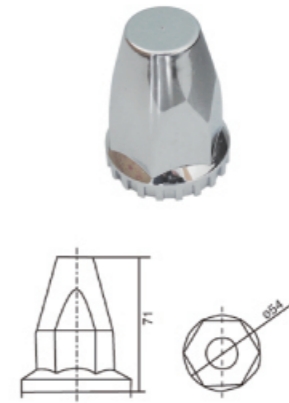

**螺纹盖**  
型号: NG05067  
Thread Cap  
Type Number: NG05067



**危险品顶灯**  
规格:  
B I 400x140x190  
B II 500x160x220  
B III 560x180x240  
Hazardous Lamp  
Specification:  
B I 400x140x190  
B II 500x160x220  
B III 560x180x240

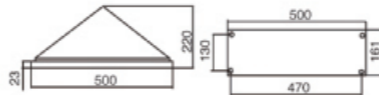

① **危险品顶灯(平顶)**  
规格:  
B I 400x140x190  
B II 500x160x220  
B III 560x180x240  
该产品带有安装支架适用于平顶车头的安装

② **危险品顶灯(导流罩)**  
规格:  
B I 400x140x190  
B II 560x180x240  
B III 500x160x220  
该产品带有安装支架适用于导流罩车头的安装

**防撞块**

规格:  
① 150x75x85  
② 160x50x60  
③  $\Phi 50$

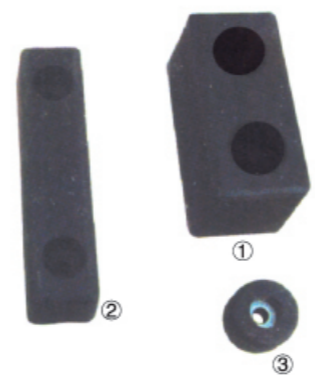

Collosion Chock  
Specification:  
① 150x75x85  
② 160x50x60  
③  $\Phi 50$

### 线束-汽车专用电缆线

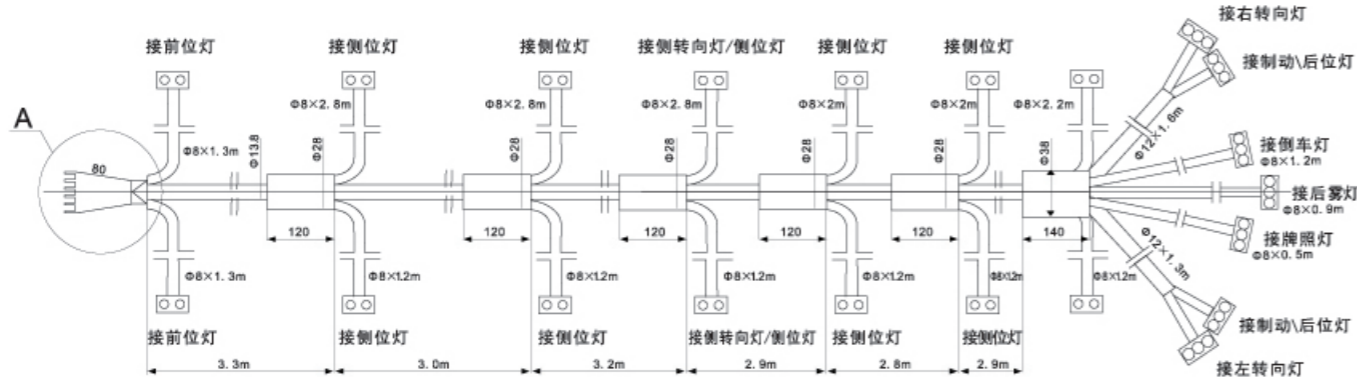

车型	规格				
骨架车	20"	40"	45"	48"	55"
平板车	20"	40"	45"	48"	55"
半挂车	13m	16m	17.5m	19m	

备注：可根据客户图纸要求定制。



### 线束-阻燃波纹管型

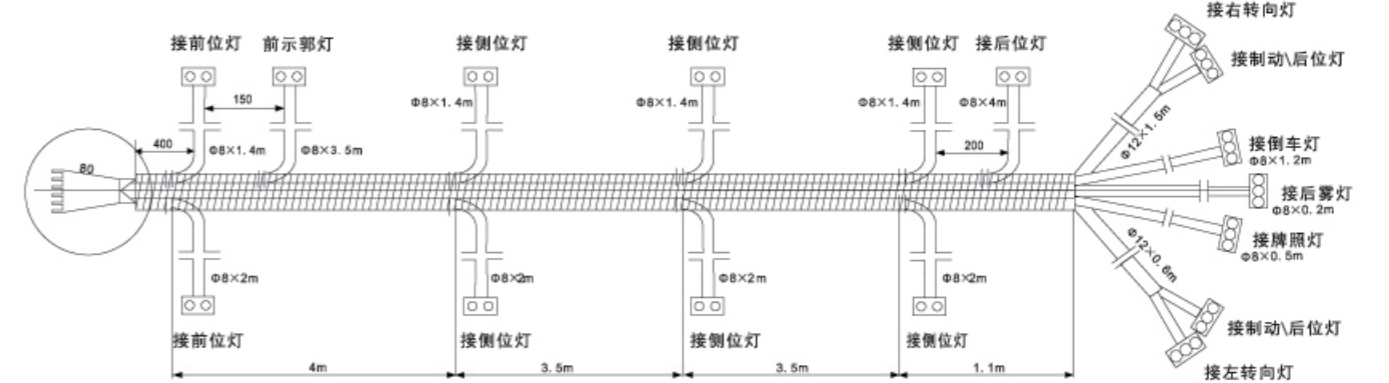

车型	规格				
骨架车	20"	40"	45"	48"	
平板车	20"	40"	45"	48"	
半挂车	13m	16m	17.5m	19m	

备注：可根据客户图纸要求定制。



防爆油罐车线束 防护等级: IP65

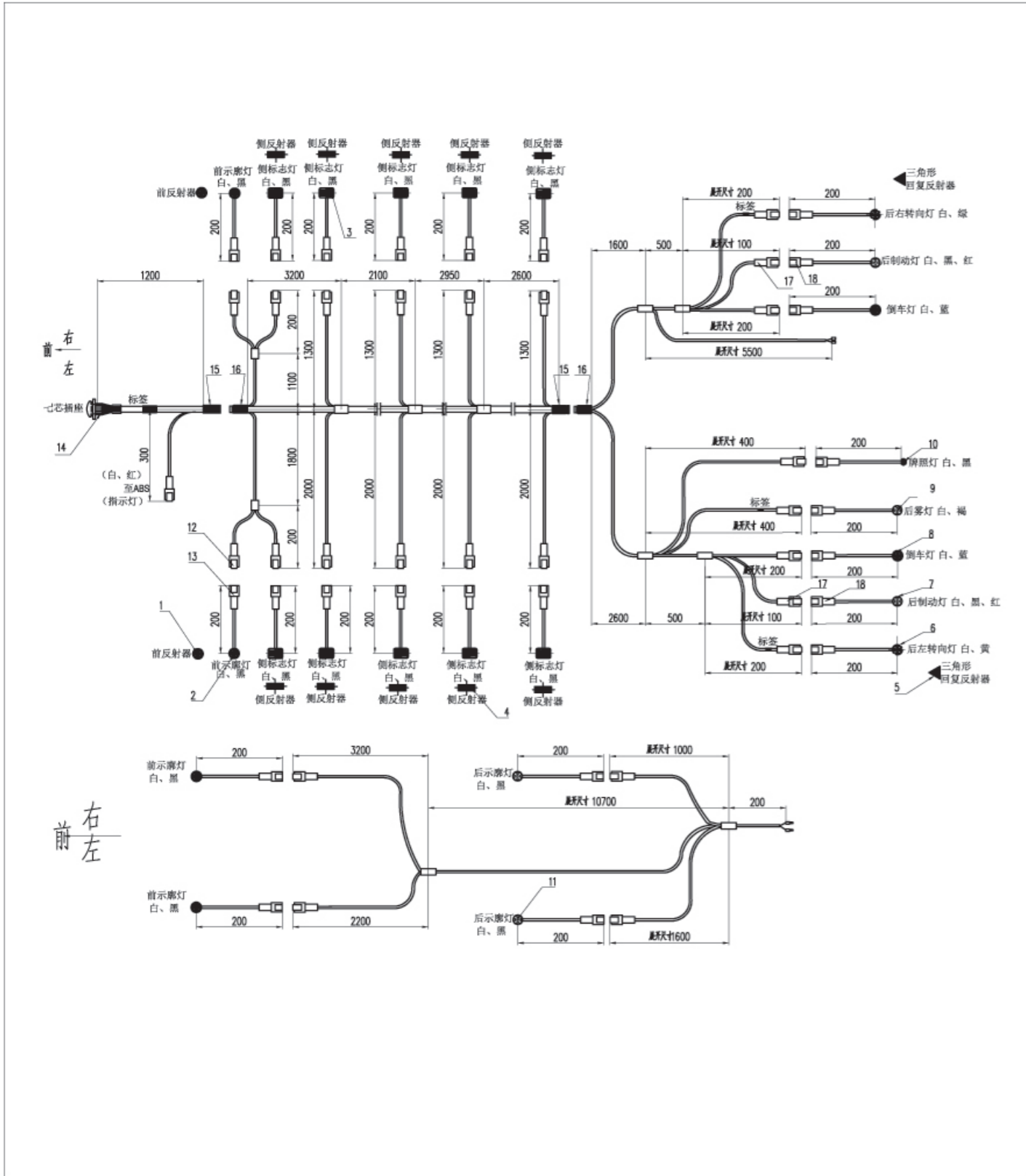

罐车线束

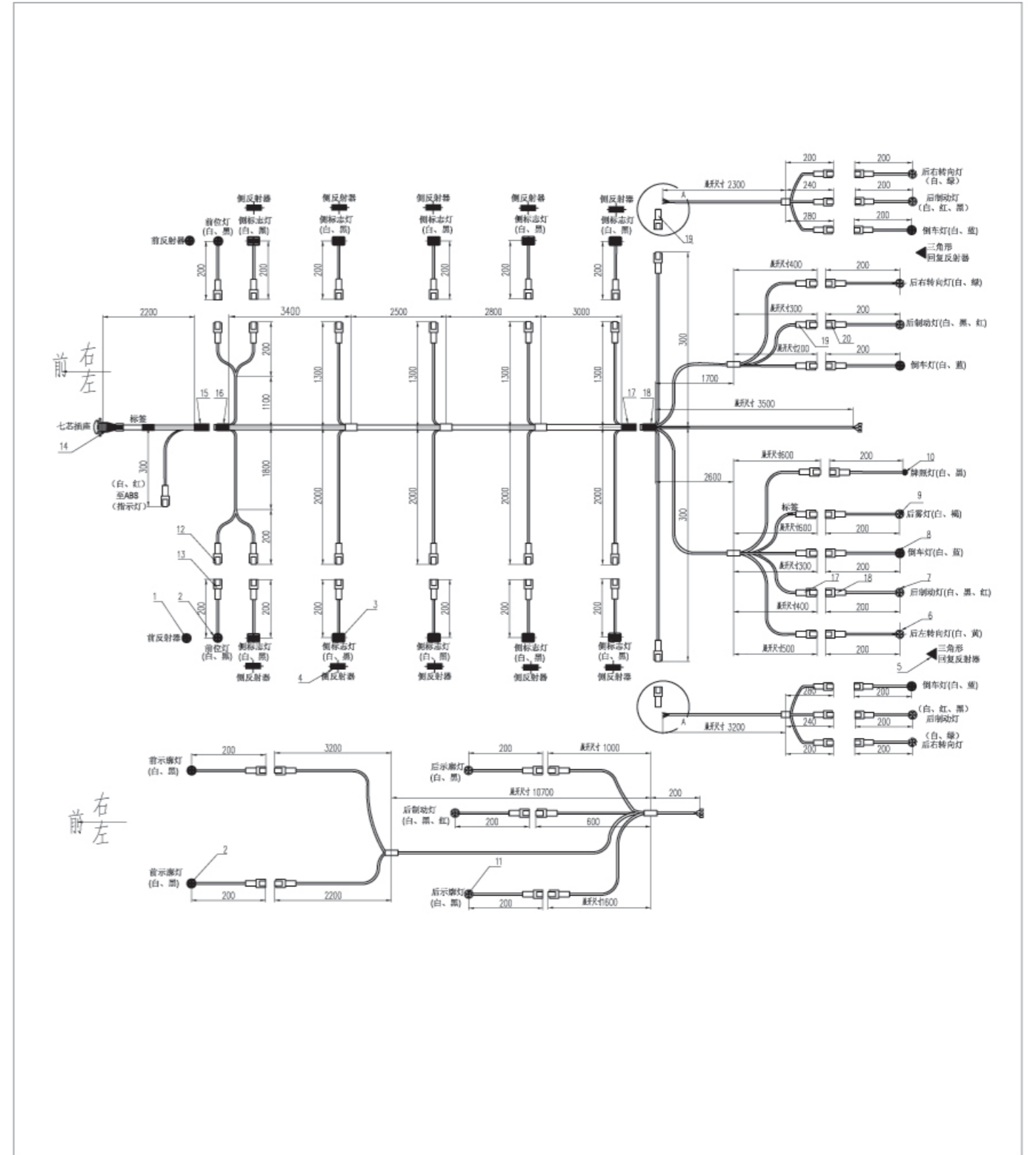



环卫车线束

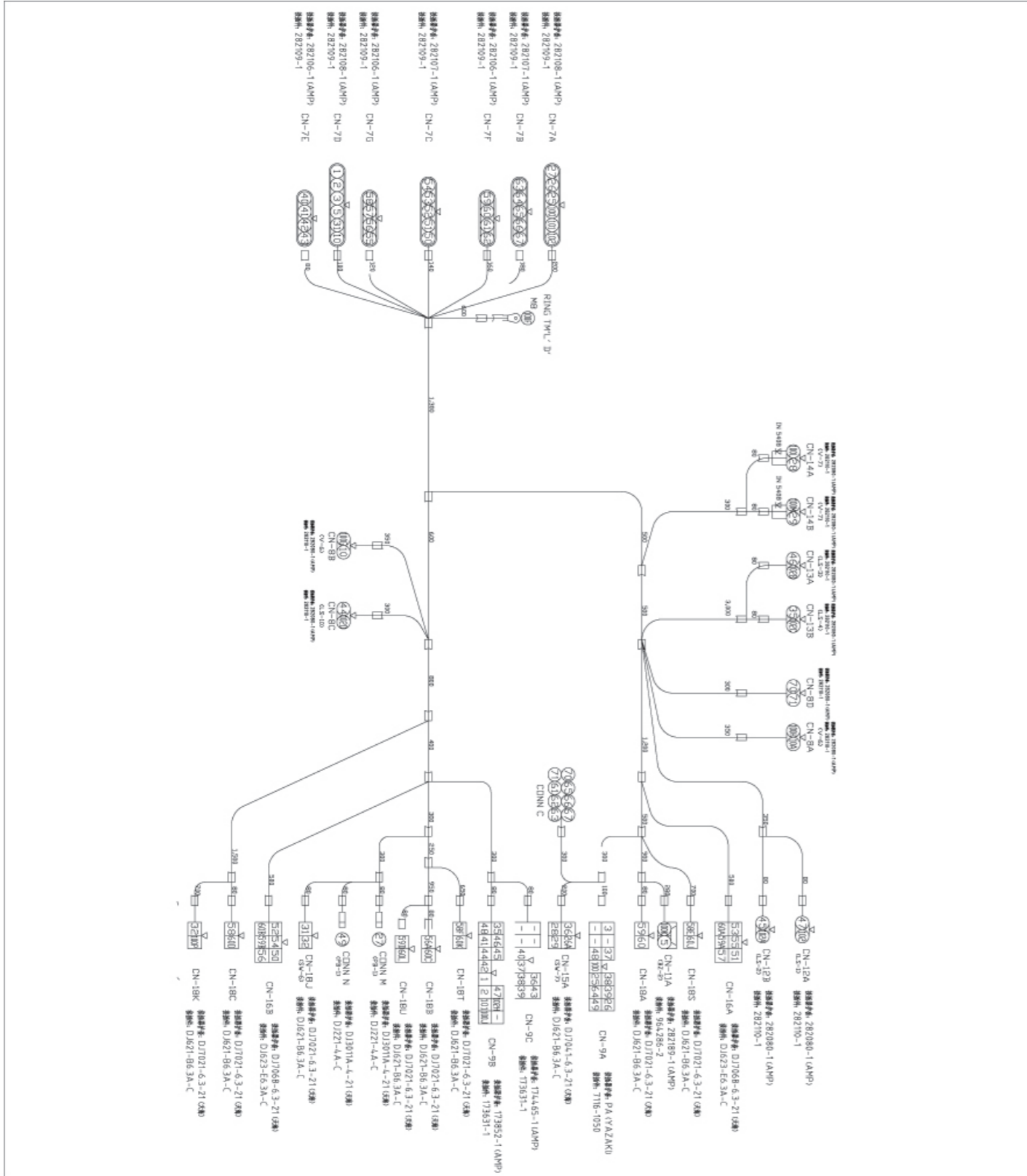

环卫车线束

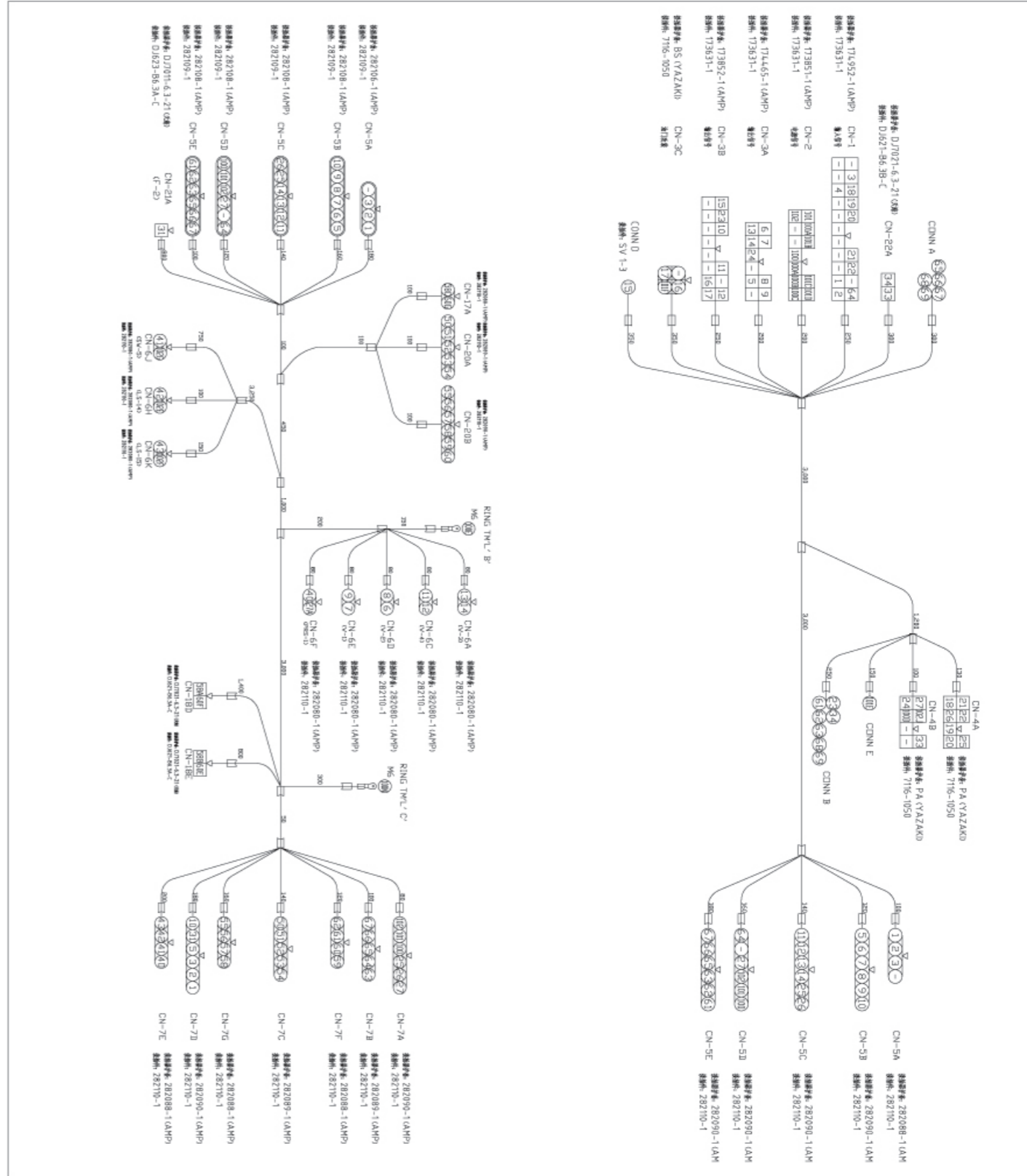



**一体式插头**  
规格: 二芯、三芯  
汽车专用电缆  
规格: 二芯、三芯、五芯、七芯

Integrated Plug  
Specification:  
Two Core/Male/Female  
Three Core/Male/Female  
Integrated Plug  
Specification:  
Two Core/ Three Core  
Five Core/ Seven Core



**开口波纹管**  
规格:  $\Phi 6$ 、 $\Phi 9$ 、 $\Phi 11$ 、 $\Phi 13$ 、 $\Phi 20$ 、 $\Phi 30$ 等

Opening Bellow  
Specification:  $\Phi 6$ 、 $\Phi 9$ 、 $\Phi 11$ 、 $\Phi 13$ 、 $\Phi 20$ 、 $\Phi 30$



**过线圈**  
规格:  $\Phi 25 \times 6.5$   
 $\Phi 25 \times 12$   
 $\Phi 38 \times 6.5$   
 $\Phi 38 \times 12$

Coil  
Specification:  
 $\Phi 25 \times 6.5$   
 $\Phi 25 \times 12$   
 $\Phi 38 \times 6.5$   
 $\Phi 38 \times 12$



**插头**  
规格:  
①七芯插头  
②七芯插座

Specification:  
①Seven core plug  
②Seven core Receptacle

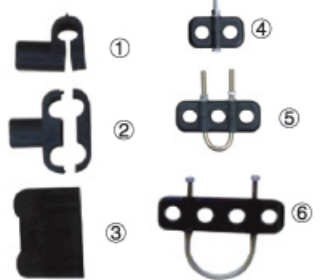

**气管夹 Trzchea Folder**  
规格: Trzchea Folder:  
①1x12 ①1x12  
②2x12 ②2x12  
③2x12 ③2x12  
④2x17 ④2x17  
⑤3x12 ⑤3x12  
⑥4x17 ⑥4x17



**线夹**  
规格:  
①不锈钢线夹  $\Phi 8/12/16/20/24$   
②钢线夹  
③尼龙线夹  $\Phi 12/24$

Wire clamp  
Specification:  
①SUS Clamp  
②Steel Clamp  
③Nylon Clamp

**NG06001**



**牌照灯(泡式)**  
型号: NG06001  
用途: 用于照明牌照板的装置。  
灯泡型号: R10W (24V10W)  
3C认证产品  
License Plate Lamp  
Type Number: NG06001  
Application: Using the license plate for lighting devices  
Bulb Mode: R10W (24V10W)  
3C Authentication



**NG06002**



**牌照灯(泡式)**  
型号: NG06002  
用途: 用于照明牌照板的装置。  
灯泡型号: R10W (24V10W)  
3C认证产品  
License Plate Lamp  
Type Number: NG06002  
Application: Using the license plate for lighting devices  
Bulb Mode: R10W (24V10W)  
3C Authentication



**NG06003**



**长2寸牌照灯(泡式)**  
型号: NG06003  
用途: 用于照明牌照板的装置。  
灯泡型号: W5W (24V5W)  
3C认证产品  
License Plate Lamp  
Type Number: NG06003  
Application: Using the license plate for lighting devices  
Bulb Mode: W5W (24V5W)  
3C Authentication



**NG07001W(白)/NG07001R(红)**



**前后示廓灯/前后位灯(泡式)**  
型号: NG07001W/NG07001R  
用途: 安装在车辆最外沿和可能靠近最顶部附近, 用来表明车宽和高灯具。  
灯泡型号: R10W (24V10W)  
3C认证产品  
F/R Clearance lamp/Parking lights  
Type Number: NG07001W/NG07001R  
Application: Fixed on the vehicle near the outer height and width of lamps  
Bulb Mode: R10(24V10W)  
3C Authentication



**NG07002W(白)/NG07002R(红)**



**前后示廓灯(泡式)**  
型号: NG07002W/NG07002R  
用途: 安装在车辆最外沿和可能靠近最顶部附近, 用来表明车宽和高灯具。  
灯泡型号: W5W (24V5W)  
3C认证产品  
F/R Clearance lamp  
Type Number: NG07002W/NG07002R  
Application: Fixed on the vehicle near the outer height and width of lamps  
Bulb Mode: W5W(24V5W)  
3C Authentication



**NG07003W(白)/NG07003R(红)**



**前后示廓灯/前后位灯(泡式)**  
型号: NG07003W/NG07003R  
用途: 安装在车辆最外沿和可能靠近最顶部附近, 用来表明车宽和高灯具。  
灯泡型号: R10W (24V10W)  
3C认证产品  
F/R Clearance lamp/Parking lights  
Type Number: NG07003W/NG07003R  
Application: Fixed on the vehicle near the outer height and width of lamps  
Bulb Mode: R10W (24V10W)  
3C Authentication



NG07004(凸)



前后示廓灯(泡式)

型号: NG07004(凸)  
用途: 安装在车辆最外沿和可能靠近最顶部附近, 用来表明车宽和高灯具。  
灯泡型号: W5W (24V5W)  
3C认证产品  
F/R Clearance lamp  
Type Number:NG07004(Convex)  
Applction: Fixed on the vehicle near the outer height and width of lamps  
Buld Mode:W5W(24V5W)  
3C Authentication

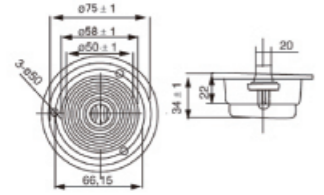

NG07004(凹)



前后示廓灯(泡式)

型号: NG07004(凹)  
用途: 安装在车辆最外沿和可能靠近最顶部附近, 用来表明车宽和高灯具。  
灯泡型号: W5W (24V5W)  
3C认证产品  
F/R Clearance lamp  
Type Number:NG07004(Concave)  
Applction: Fixed on the vehicle near the outer height and width of lamps  
Buld Mode:W5W(24V5W)  
3C Authentication

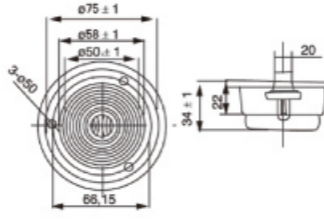

NG08001



倒车灯(泡式)

型号: NG08001  
用途: 照明车辆后方道路和其它道路的使用情况, 表明车辆正在和即将倒车的灯。  
灯泡型号: P21W (24V21W)  
3C认证产品  
Backup Lamp  
Type Number:NG08001  
Application:Lighting vehicle rear roads and other roads The use of vehicles indicates that the vehicle is reversing Auto lamp.  
Buld Mode: P21W (24V21W)  
3C Authentication

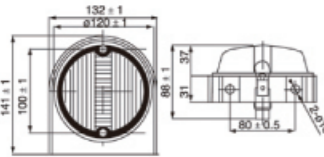

NG08002



倒车灯(泡式)

型号: NG08002  
用途: 照明车辆后方道路和其它道路的使用情况, 表明车辆正在和即将倒车的灯。  
灯泡型号: P21W (24V21W)  
3C认证产品  
Backup Lamp  
Type Number:NG08002  
Application:Lighting vehicle rear roads and other roads The use of vehicles indicates that the vehicle is reversing Auto lamp.  
Buld Mode: P21W (24V21W)  
3C Authentication

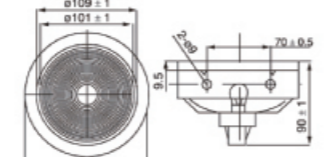

NG08010



后雾灯(泡式)

型号: NG08010  
用途: 在大雾的情况下, 从车辆后面观察, 表明车辆的行驶位置, 使得车辆更为易见。  
灯泡型号: P21W (24V21W)  
3C认证产品  
Rear Fog Lamp  
Type Number:NG08010  
Application:In the circumstances,the observation from the Rear of Vehicles Vehicle makes it easier to see the lights  
Buld Mode: P21W (24V21W)  
3C Authentication

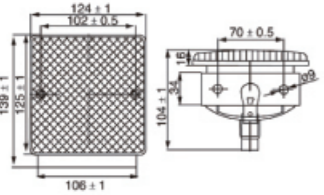

NG08011



后雾灯(泡式)

型号: NG08011  
用途: 在大雾的情况下, 从车辆后面观察, 表明车辆的行驶位置, 使得车辆更为易见。  
灯泡型号: P21W (24V21W)  
3C认证产品  
Rear Fog Lamp  
Type Number:NG08011  
Application:In the circumstances,the observation from the Rear of Vehicles Vehicle makes it easier to see the lights  
Buld Mode: P21W (24V21W)  
3C Authentication

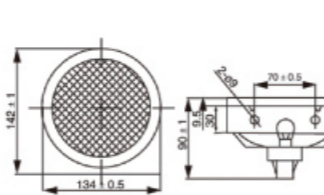

NG08020



侧向信号灯

型号: NG08020  
用途: 用于车辆侧面, 表明车辆向左或向右转向的灯具  
灯泡型号: P21W/5W (21V21/5W)  
3C认证产品  
Side Signal Lamp  
Type Number:NG08020  
Applction: For vehicle side,shown the vehicle the left of right lamps  
Buld Mode: P21W/5W (21V21/5W)  
3C Authentication

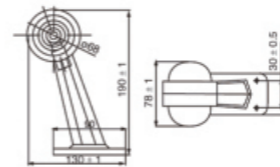

NG08040



工作灯(泡式)

型号: NG08040  
用途: 表明车辆有作业, 也可以作为倒车时的辅助灯具, 可以上下左右调节角度。  
灯泡型号: H3、24V55W、12V55W  
Work Lamp  
Type Number:NG08040  
Applction: Indicating that the vehicle is in operation and reversing auxiliary lamps,lamps can be up and down around the angle adjustment.  
Buld Mode: H3、24V55W、12V55W

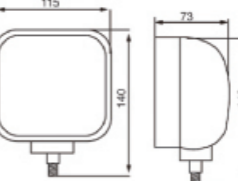

NG08041



工作灯(泡式)

型号: NG08041  
用途: 表明车辆有作业, 也可以作为倒车时的辅助灯具, 可以上下左右调节角度。  
灯泡型号: R224281、24V55/50W  
Work Lamp  
Type Number:NG08041  
Applction: Indicating that the vehicle is in operation and reversing auxiliary lamps,lamps can be up and down around the angle adjustment.  
Buld Mode: R224281、24V55/50W

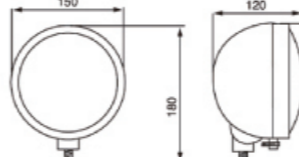

NG09001 NG09002



2寸圆灯、安装环

型号: NG09001 (前位灯)  
NG09002 (后位灯)  
NG09003 (侧标志灯)  
NG09004 (安装环)  
用途: 前后示廓灯、前后位灯、侧标志灯。  
3C认证产品  
2" Round Lamp/Erection loop  
Applction: F/R Outline Marker lamp, F/R Position lamp and side signal lamp  
3C Authentication



NG09011 NG09012

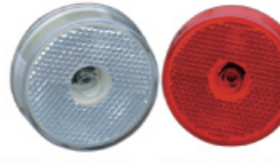

2.5寸圆灯(带反射器)、安装环

型号: NG09011 (前位灯)  
NG09012 (后位灯)  
NG09013 (侧标志灯)  
NG09017 (安装环)  
用途: 前后示廓灯、前后位灯、侧标志灯。  
灯泡型号: W5W (24V5W)  
3C认证产品  
2.5" Round Lamp/Erection loop  
Applction: F/R Outline Marker lamp, F/R Position lamp and side signal lamp  
3C Authentication



NG09021 NG09022



4寸圆灯、安装环

型号: NG09021 (制动/后位)  
NG09022 (倒车) NG09023 (转向)  
NG09024 (后雾) NG09025 (安装环)  
用途: 具有制动/后位、转向、倒车、后雾灯功能, 具有牢固性、密封性、抗震的特点。  
灯泡型号: P21W (24V21W)  
3C认证产品  
4" Round Lamp/Erection loop  
Applction: Having a break/rear position, turning,reversing,rear fog lamp with firmness.the seal the asselismic function.  
3C Authentication



**NG09031**



**前示廓灯**

型号: NG09031  
用途: 前示廓灯  
3C认证产品

Front Clearance lamp  
Type Number:NG09031  
Application:With the functions of front&rear marker lamp and side signal lamp.

3C Authentication

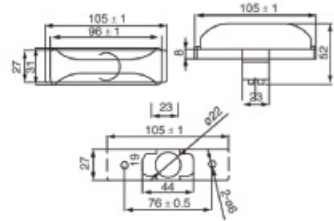

**NG09032**



**侧标志灯**

型号: NG09032  
用途: 侧标志灯  
3C认证产品

Side Marker lamp  
Type Number:NG09032  
Application:With the functions of front&rear marker lamp and side signal lamp.

3C Authentication

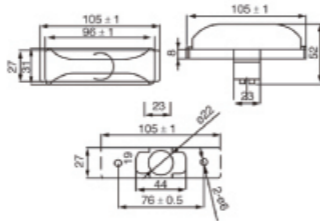

**NG09053**



型号: NG09053(灯泡式)  
用途: 汽车倒车灯  
3C认证产品

Type Number:NG09053  
3C Authentication

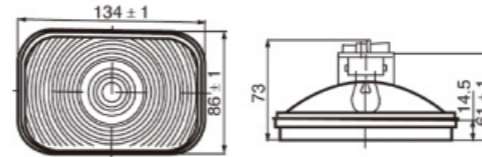

**NG09054**



型号: NG09054(灯泡式)  
用途: 汽车后雾灯  
3C认证产品

Type Number:NG09054  
3C Authentication

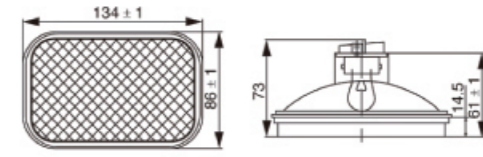

**NG09033**



**后示廓灯**

型号: NG09033  
用途: 后示廓灯  
Rear Clearance lamp

Type Number:NG09033  
Application:With the functions of front&rear marker lamp and side signal lamp.

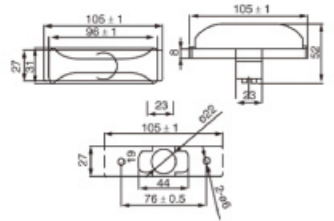

**NG09040**



**6寸椭圆灯(泡式)**

型号: NG09040  
用途: 侧转向灯、侧标志灯、侧反射器  
3C认证产品

6" Elliptic lamp  
Type Number:NG09040  
Application:With the functions of side turn lamp,side signal lamp and side reflector

3C Authentication

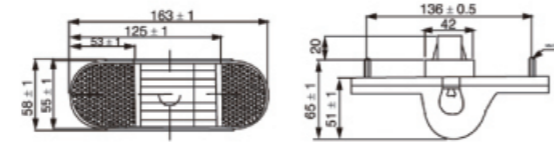

**NG09051**



型号: NG09051(灯泡式)  
用途: 汽车后位/制动灯  
3C认证产品

Type Number:NG09051  
3C Authentication

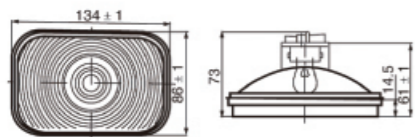

**NG09052**



型号: NG09052(灯泡式)  
用途: 汽车转向灯  
3C认证产品

Type Number:NG09052  
3C Authentication

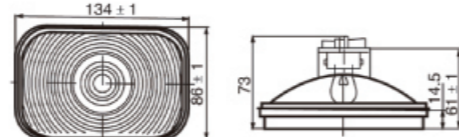

NG09110 NG09112



**2寸LED灯、安装环**  
型号: NG09110(前示廓灯)/3C认证  
NG09112(后示廓灯)/3C/E-mark认证  
NG09111(侧标志灯)/3C认证  
NG09004(2寸安装环)  
2" Lamp/Erection loop  
Type Number:  
NG09110(F.Clearance lamp)/  
3C Authentication  
NG09112(R.Clearance lamp)/  
3C Authentication/E-mark Authentication  
NG09111(Side Signal lamp)/  
3C Authentication  
NG09004(2"Erection loop)

NG09111 NG09004



NG09116



NG09025

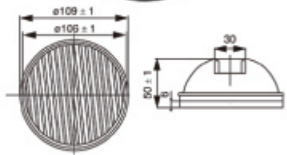

**制动/后位**  
型号: NG09116 (制动/后位)  
NG09025 (安装环)  
性能: LED具有高亮度、功率低、密封性好、寿命长、100%防水性等特点。  
LED数量: 56 电压: 24V  
3C认证产品  
Type Number: NG09116、NG09025  
Description: With the functions of stop lamp,Rear position lamp and turn lamp LED hashigh brightness,low power, good sealing and long life, 100% waterproof.  
LED quantity: 56  
Voltage: 24V  
3C Authentication

NG09118



NG09025

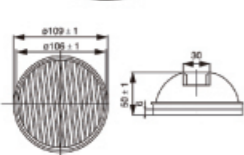

**4寸LED圆灯(倒车灯)**  
型号: NG09118 (倒车)  
NG09025 (安装环)  
性能: LED具有高亮度、功率低、密封性好、寿命长、100%防水性等特点。  
LED数量: 56 电压: 24V  
3C认证产品  
4" Round lamp LED  
Type Number: NG09118、NG09025  
Description: With the functions of stop lamp,Rear position lamp and turn lamp LED hashigh brightness,low power, good sealing and long life, 100% waterproof.  
LED quantity: 56 Voltage: 24V  
3C Authentication

NG09113 NG09115



NG09114 NG09017

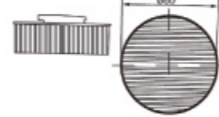

**2.5寸LED圆灯(带反射器)安装环 (可带法兰盘)**  
型号: NG09113 (前位灯带反射器)  
NG09114 (侧标志灯)  
NG09115 (后示廓灯)  
NG09017 (2.5寸安装环)  
3C认证产品  
2.5" Round lamp/Erection loop  
Type Number:  
NG09113 ( F.Lamp With reflector )  
NG09114 ( Side marker lamps )  
NG09115 ( R.Clearance lamp )  
NG09017 ( 2.5" Erection loop )  
3C Authentication

NG09117



NG09025

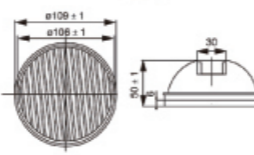

**4寸LED圆灯(转向灯)**  
型号: NG09117 (转向)  
NG09025 (安装环)  
性能: LED具有高亮度、功率低、密封性好、寿命长、100%防水性等特点。  
LED数量: 56 电压: 24V  
3C认证产品  
4" Round lamp LED  
Type Number: NG09117、NG09025  
Description: With the functions of stop lamp,Rear position lamp and turn lamp LED hashigh brightness,low power, good sealing and long life, 100% waterproof.  
LED quantity: 56 Voltage: 24V  
3C Authentication

NG09119



NG09025

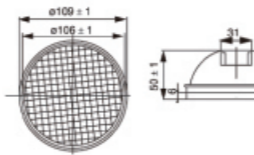

**4寸LED圆灯(后雾灯)**  
型号: NG09119 (后雾)  
NG09025 (安装环)  
性能: LED具有高亮度、功率低、密封性好、寿命长、100%防水性等特点。  
LED数量: 56 电压: 24V  
3C认证产品  
4" Round lamp LED  
Type Number: NG09118、NG09025  
Description: With the functions of stop lamp,Rear position lamp and turn lamp LED hashigh brightness,low power, good sealing and long life, 100% waterproof.  
LED quantity: 56 Voltage: 24V  
3C Authentication

NG09120Y



**长4寸LED灯**  
型号: NG09120Y  
用途: 侧标志灯  
LED数量: 6 电压: 24V  
3C认证产品  
4" Rectangle lamp LED  
Type Number:NG09120Y  
Application: With the function of front& rear marker lamp and side signal lamp  
LED quantity:6 Voltage:24V  
3C Authentication

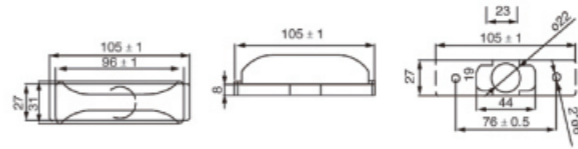

NG09122R

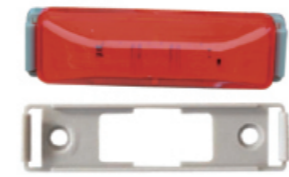

**长4寸LED灯**  
型号: NG09122R  
用途: 后示廓灯  
LED数量: 6 电压: 24V  
3C认证产品  
4" Rectangle lamp LED  
Type Number:NG09120R  
Application: With the function of front& rear marker lamp and side signal lamp  
LED quantity:6 Voltage:24V  
3C Authentication

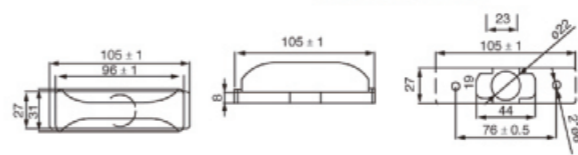

NG09124



型号: NG09124  
用途: 侧转向灯、侧标志灯、侧反射器的功能, 具有超高亮度、强耐化学性、100%防水性的特点。  
LED数量: 24 电压: 24V  
3C认证产品  
2"x6" Ellipse lamp LED  
Type Number:NG09124  
Application: With the side turn lamp, side signal lamp and side reflector. 24pcs super bright Flux LED with UV polycarbonate lens for enhanced chemical resistance 100% waterproof.  
LED quantity:24 Voltage:24V  
3C Authentication

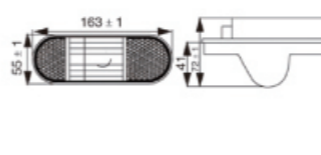

NG09121W

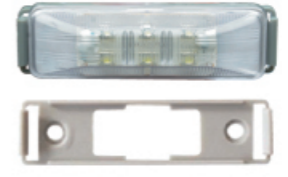

**长4寸LED灯**  
型号: NG09121W  
用途: 示廓灯  
LED数量: 6 电压: 24V  
3C认证产品  
4" Rectangle lamp LED  
Type Number:NG09120W  
Application: With the function of front& rear marker lamp and side signal lamp  
LED quantity:6 Voltage:24V  
3C Authentication

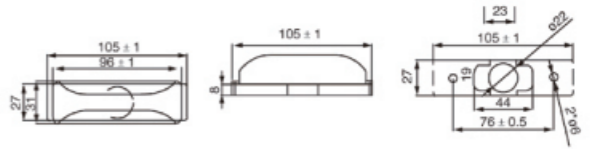

NG09123



**长2寸LED牌照灯**  
型号: NG09123  
用途: 照明牌照板的装置, 采用6颗LED, 具有超高亮度、强耐化学性、100%防水性的特点。  
LED数量: 6 电压: 24V  
3C认证产品 E-mark认证产品  
2"Rectangle License plate lamp LED  
Type Number:NG09123  
Application: Using the license plate for lighting devices 6 pcs super bright Flux LED with UV polycarbonate lens for enhanced chemical resistance 100% waterproof.  
LED quantity:6 Voltage:24V  
3C Authentication  
E-markAuthentication

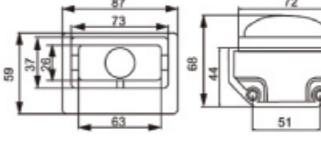

NG09130



型号: NG09130  
用途: LED侧标志灯, 带回复反射器  
电压: 24V  
3C认证产品 E-mark认证产品  
Type Number:NG09130  
Application: LED side marker lights, With Reflector.  
Voltage:24V  
3C Authentication  
E-markAuthentication

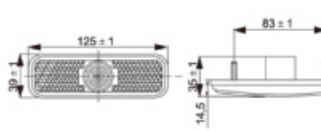

**NG09131**



型号: NG09131  
用途: LED侧标志灯, 带回复反射器  
电压: 24V  
**3C认证产品**  
Type Number: NG09131  
Application: LED side marker lights, with side reflector  
Voltage: 24V  
**3C Authentication**

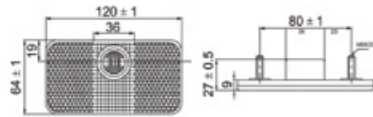

**NG09132**



型号: NG09132  
用途: LED侧标志灯, 带回复反射器  
LED数量: 5 电压: 24V  
**3C认证产品**  
Type Number: NG09132  
Application: LED side marker lights, with side reflector  
LED quantity: 5  
Voltage: 24V  
**3C Authentication**

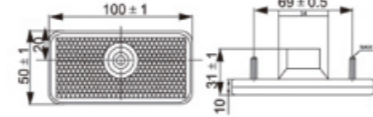

**NG09133**



型号: NG09133  
用途: LED侧标志灯, 带回复反射器  
电压: 24V  
**3C认证产品**  
Type Number: NG09133  
Application: LED side marker lights, with side reflector  
Voltage: 24V  
**3C Authentication**

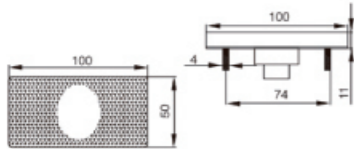

**NG09207**



型号: NG09207  
用途: LED侧标志灯, 带反射器  
描述: LED具有高亮度、功率低、密封性好、寿命长, 100%防水性好的特点。  
LED数量: 6 电压: 24V  
**3C认证产品**  
Side Lamp LED  
Type Number: NG09207  
Description: LED has high brightness, low power, good sealing and long life, 100% waterproof.  
LED quantity: 6 Voltage: 24V  
**3C Authentication**

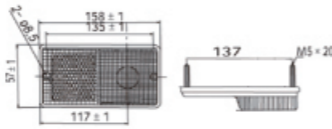

**NG09207-1**

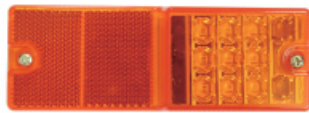

型号: NG09207-1  
用途: LED侧标志灯, 带反射器  
描述: LED具有高亮度、功率低、密封性好、寿命长, 100%防水性好的特点。  
电压: 12/24V  
**3C认证产品**  
Side Lamp LED  
Type Number: NG09207-1  
Description: LED has high brightness, low power, good sealing and long life, 100% waterproof.  
LED quantity: 9 Voltage: 12/24V  
**3C Authentication**

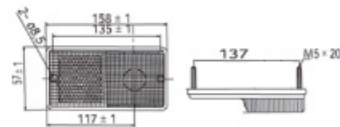

**NG09135**



牌照灯  
型号: NG09135  
用途: 采用6颗LED, 具有超高亮度、强耐化学性、100%防水性的特点。  
LED数量: 6 电压: 24V  
**3C认证产品**  
License Plate lamp  
Type Number: NG09135  
Description: 6pcs super bright Flux LED with UV Polycarbonate lens for enhanced chemical resistance 100% waterproof.  
LED quantity: 6 Voltage: 24V  
**3C Authentication**

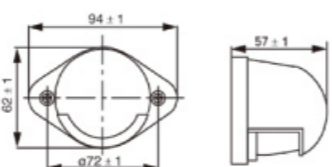

**NG09136**



型号: NG09136  
性能: 采用6颗LED, 具有超高亮度、强耐化学性、100%防水性的特点。  
LED数量: 6 电压: 24V  
**3C认证产品**  
License Plate lamp  
Type Number: NG09136  
Description: 6 pcs super bright Flux LED with UV polycarbonate lens for enhanced chemical resistance 100% waterproof.  
LED quantity: 6 Voltage: 24V  
**3C Authentication**

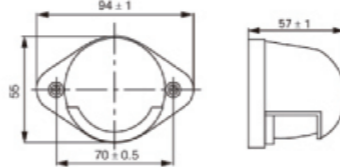

**NG09202**



后组合灯LED  
型号: NG09202(由NG09116/117组成)  
用途: 具有制动灯、后位灯、转向灯的功能, LED具有高亮度、功率低、密封性好、寿命长等特点。  
LED数量: 56/56 电压: 24V  
**3C认证产品**  
Tail Lamps  
Type Number: NG09202  
Application: With the function of stop lamp, rear position lamp and turn lamp LED has high brightness, low power, good sealing and long life, 100% waterproof.  
LED quantity: 56/56 Voltage: 24V  
**3C Authentication**

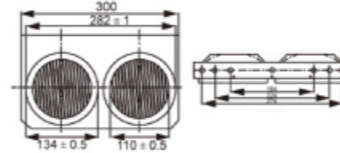

**NG09201**



后组合灯LED  
型号: NG09201(由NG09125/126组成)  
用途: 具有制动灯、后位灯、转向灯的功能, LED具有高亮度、功率低、密封性好、寿命长等特点。  
LED数量: 56/56 电压: 24V  
**3C认证产品**  
Tail Lamps  
Type Number: NG09201  
Application: With the function of stop lamp, rear position lamp and turn lamp LED has high brightness, low power, good sealing and long life, 100% waterproof.  
LED quantity: 56/56 Voltage: 24V  
**3C Authentication**

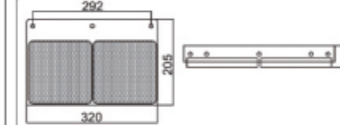
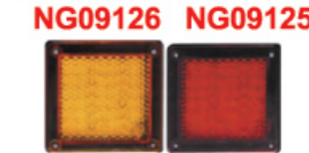

**NG09202-1**



后组合灯LED  
型号: NG09202-1  
(由NG09116/117/118组成)  
用途: 具有制动灯、后位灯、转向灯、倒车灯的功能, LED具有高亮度、功率低、密封性好、寿命长等特点。  
LED数量: 56/56/56 电压: 24V  
**3C认证产品**  
Tail Lamps  
Type Number: NG09202-1  
Application: With the function of stop lamp, rear position lamp and turn lamp LED has high brightness, low power, good sealing and long life, 100% waterproof.  
LED quantity: 56/56/56 Voltage: 24V  
**3C Authentication**

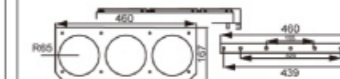

**NG09203-1**



后组合灯LED  
型号: NG09203-1  
(由NG09125/126/127组成)  
用途: 具有制动灯、后位灯、转向灯、倒车灯的功能, LED具有高亮度、功率低、密封性好、寿命长等特点。  
电压: 24V  
**3C认证产品**  
Rear Fog lamp LED  
Type Number: NG09203-1  
Application: LED has high brightness, low power, good sealing and long life, 100% waterproof.  
Voltage: 24V  
**3C Authentication**

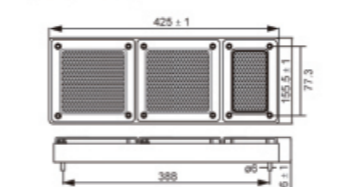
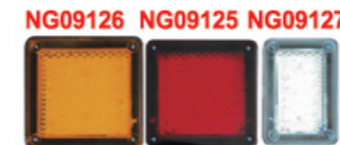

**NG09203-2**



后组合灯LED  
型号: NG09203-2  
(由NG09128/129/130组成)  
用途: 具有制动灯、后位灯、转向灯、倒车灯的功能, LED具有高亮度、功率低、密封性好、寿命长等特点。  
电压: 24V  
**3C认证产品**  
Rear Fog lamp LED  
Type Number: NG09203-2  
Application: LED has high brightness, low power, good sealing and long life, 100% waterproof.  
Voltage: 24V  
**3C Authentication**

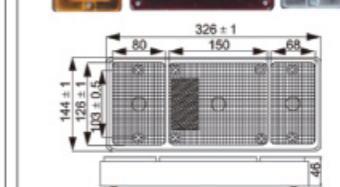

NG09203-3

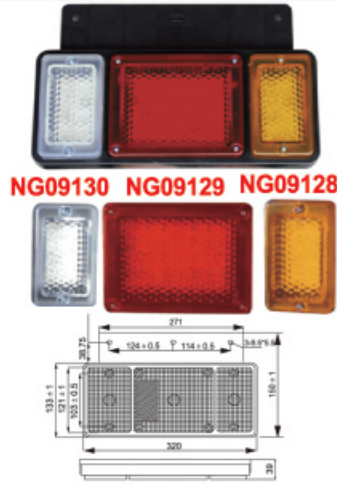

后组合灯LED

型号: NG09203-3  
(由NG09128/129/130组成)  
用途: 具有制动灯、后位灯、转向灯、倒车灯的功能, LED具有高亮度、功率低、密封性好、寿命长等特点。  
电压: 24V  
**3C认证产品**  
Rear Fog lamp LED  
Type Number:NG09203-3  
Applition: LED has high brightness, low power,good sealing and long life, 100% waterproof.  
Voltage:24V  
**3C Authentication**

NG09307

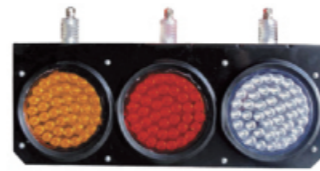

NG09152 NG09151 NG09153

后组合灯LED

型号: NG09307  
(由NG09151制动、后位/NG09152转向/NG09153倒车组成)  
用途: 具有制动灯、后位灯、转向灯、倒车灯的功能, LED具有高亮度、功率低、密封性好、寿命长等特点。  
LED数量: 40/40/40 电压: 24V  
**3C认证产品**  
Tail Lamps Type Number:NG09307  
Applition: With the function of stop lamp,rear position lamp and turn lamp LED has high brightness,low power, good sealing and long life,100% waterproof.  
LED quantity:40/40/40 Voltage:24V  
**3C Authentication**

NG09308



NG09162 NG09161 NG09163

后组合灯LED

型号: NG09308  
(由NG09161制动、后位/NG09162转向/NG09163倒车组成)  
用途: 具有制动灯、后位灯、转向灯、倒车灯的功能, LED具有高亮度、功率低、密封性好、寿命长等特点。  
LED数量: 24/24/24 电压: 24V  
**3C认证产品**  
Tail Lamps Type Number:NG09308  
Applition: With the function of stop lamp,rear position lamp and turn lamp LED has high brightness,low power, good sealing and long life,100% waterproof.  
LED quantity:24/24/24 Voltage:24V  
**3C Authentication**

NG09309

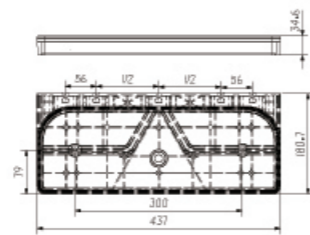

后组合灯LED

型号: NG09309  
用途: 具有制动灯、后位灯、转向灯、后雾灯、倒车灯的功能, LED具有高亮度、功率低、密封性好、寿命长等特点。  
电压: 24V  
Tail Lamps Type Number:NG09309  
Applition: With the function of stop lamp,Rear Fog lamprear position lamp and turn lamp.  
LED has high brightness,low power, good sealing and long life,100% waterproof.  
Voltage:24V

NG09156



4寸LED制动/后位灯

型号: NG09156(制动/后位)  
(原NG09222)  
描述: LED具有高亮度、功率低、密封性好、寿命长、100%防水等特点。  
LED数量: 24  
电压: 24V  
**3C认证产品**  
4 " Tail Lamps  
Type Number:NG09156  
Description: LED has high brightness, low power,good sealing and long life 100% waterproof.  
LED quantity:24 Voltage:24V  
**3C Authentication**

NG09157



4寸LED转向灯

型号: NG09157(转向)  
(原NG09222)  
描述: LED具有高亮度、功率低、密封性好、寿命长、100%防水等特点。  
LED数量: 24 电压: 24V  
**3C认证产品**  
4 " Tail lamp  
Type Number: NG09157  
Description: LED has high brightness, low power,good sealing and long life, 100% waterproof.  
LED quantity: 24 Voltage: 24V  
**3C Authentication**

NG09158



4寸LED倒车灯

型号: NG09158(倒车)  
(原NG09222)  
描述: LED具有高亮度、功率低、密封性好、寿命长、100%防水等特点。  
LED数量: 24 电压: 24V  
**3C认证产品**  
4 " Tail lamp  
Type Number: NG09158  
Description: LED has high brightness, low power,good sealing and long life, 100% waterproof.  
LED quantity: 24 Voltage: 24V  
**3C Authentication**

NG09161



6寸LED制动/后位灯

型号: NG09161(制动/后位)  
描述: LED具有高亮度、功率低、密封性好、寿命长、100%防水等特点。  
LED数量: 24  
电压: 24V  
**3C认证产品**  
6 " Tail Lamps  
Type Number:NG09161  
Description: LED has high brightness, low power,good sealing and long life 100% waterproof.  
LED quantity:24 Voltage:24V  
**3C Authentication**

NG09159



4寸LED后雾灯

型号: NG09159(后雾)  
描述: LED具有高亮度、功率低、密封性好、寿命长、100%防水等特点。  
LED数量: 24 电压: 24V  
**3C认证产品**  
4 " Tail lamp  
Type Number: NG09159  
Description: LED has high brightness, low power,good sealing and long life, 100% waterproof.  
LED quantity: 24 Voltage: 24V  
**3C Authentication**

NG09162



6寸LED转向灯

型号: NG09162(转向)  
描述: LED具有高亮度、功率低、密封性好、寿命长、100%防水等特点。  
LED数量: 24  
电压: 24V  
**3C认证产品**  
6 " Tail Lamps  
Type Number:NG09162  
Description: LED has high brightness, low power,good sealing and long life 100% waterproof.  
LED quantity:24 Voltage:24V  
**3C Authentication**

NG09163



6寸LED倒车灯

型号: NG09163(倒车)  
描述: LED具有高亮度、功率低、密封性好、寿命长、100%防水等特点。  
LED数量: 24  
电压: 24V  
**3C认证产品**  
6 " Tail Lamps  
Type Number:NG09163  
Description: LED has high brightness, low power,good sealing and long life 100% waterproof.  
LED quantity:24 Voltage:24V  
**3C Authentication**

NG09171



4寸LED制动/后位灯

型号: NG09171(制动/后位)  
描述: LED具有高亮度、功率低、密封性好、寿命长、100%防水等特点。  
LED数量: 24 电压: 24V  
**3C认证产品**  
4 " Tail lamp  
Type Number: NG09160  
Description: LED has high brightness, low power,good sealing and long life, 100% waterproof.  
LED quantity: 24 Voltage: 24V  
**3C Authentication**

NG09172



**4寸LED转向灯**  
型号: NG09172(转向)  
描述: LED具有高亮度、功率低、密封性好、寿命长、100%防水等特点。  
LED数量: 24 电压: 24V  
3C认证产品  
4" Tail lamp  
Type Number: NG09161  
Description: LED has high brightness, low power, good sealing and long life, 100% waterproof.  
LED quantity: 24 Voltage: 24V  
3C Authentication

NG09173



**4寸LED倒车灯**  
型号: NG09173(倒车)  
描述: LED具有高亮度、功率低、密封性好、寿命长、100%防水等特点。  
LED数量: 24 电压: 24V  
3C认证产品  
4" Tail lamp  
Type Number: NG09162  
Description: LED has high brightness, low power, good sealing and long life, 100% waterproof.  
LED quantity: 24 Voltage: 24V  
3C Authentication

NG09174



**4寸LED后雾灯**  
型号: NG09174(后雾)  
描述: LED具有高亮度、功率低、密封性好、寿命长、100%防水等特点。  
LED数量: 24 电压: 24V  
3C认证产品  
4" Tail lamp  
Type Number: NG09163  
Description: LED has high brightness, low power, good sealing and long life, 100% waterproof.  
LED quantity: 24 Voltage: 24V  
3C Authentication

NG09204



型号: NG09204  
用途: LED汽车前示廓灯  
LED数量: 6 电压: 24V  
3C认证产品  
Tail Lamps  
Type Number: NG09204  
Application: LED Front Clearance lamp  
LED quantity: 6 Voltage: 24V  
3C Authentication

NG09205

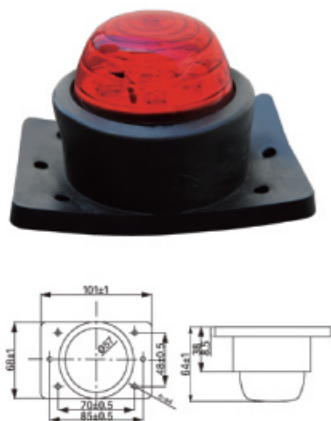

型号: NG09205  
用途: LED汽车后示廓灯  
LED数量: 6 电压: 24V  
3C认证产品  
Tail Lamps  
Type Number: NG09205  
Application: LED Rear Clearance lamp  
LED quantity: 6 Voltage: 24V  
3C Authentication

NG09206

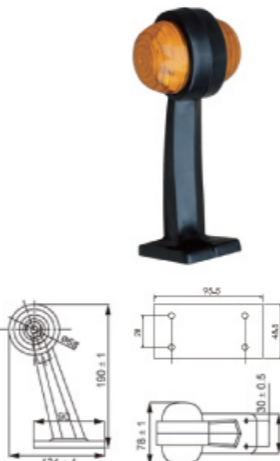

**LED侧标志灯**  
型号: NG09206  
用途: 用于车辆侧面, 表明车辆向左或向右的灯具, LED具有高亮度、功率低、密封性好、寿命长、100%防水等特点。  
LED数量: 6/6 电压: 24V  
3C认证产品  
Tail Lamps  
Type Number: NG09206  
Application: LED has high brightness, low power, good sealing and long life, 100% waterproof.  
LED quantity: 6/6 Voltage: 24V  
3C Authentication

NG09220

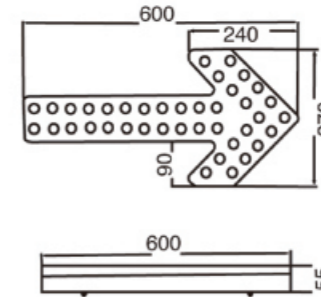
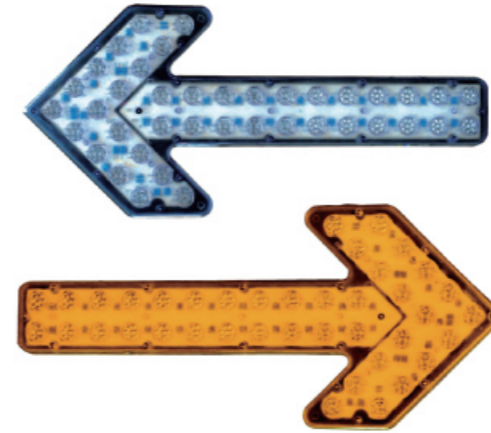

**LED箭头指示灯(黄/白)**  
型号: NG09220  
描述: LED具有超高亮度, 功率低、密封性好、寿命长、100%防水的特点用于道路清扫车、洒水车、道路方向指示等。  
LED数量: 640 电压: 12/24V  
Arrow Lamp LED  
Type Number: NG09220  
Description: with the functions of stop lamp, Rear position lamp and turn lamp, 640PCS super bright Flux LED With UV polycarbonate lens for enhanced chemical resistance 100% waterproof.  
LED quantity: 36/36/36  
Voltage: 24V/12V/9-30V

NG09220-1

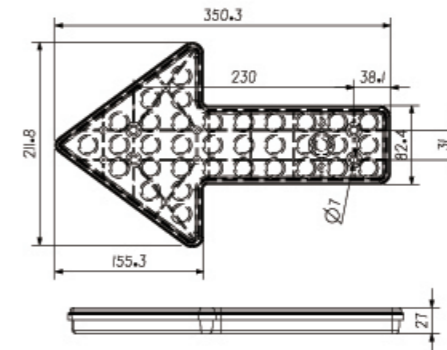
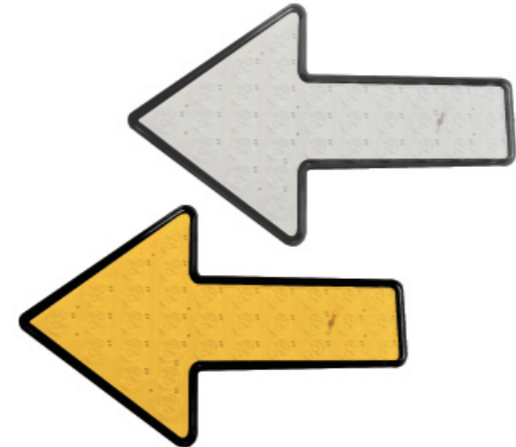

**LED箭头指示灯(黄/白)**  
型号: NG09220-1  
描述: LED具有超高亮度, 功率低、密封性好、寿命长、100%防水的特点用于道路清扫车、洒水车、道路方向指示等。  
LED数量: 204 电压: 12/24V  
Arrow Lamp LED  
Type Number: NG09220-1  
Description: with the functions of stop lamp, Rear position lamp and turn lamp, 204PCS super bright Flux LED With UV polycarbonate lens for enhanced chemical resistance 100% waterproof.  
LED quantity: 36/36/36  
Voltage: 24V/12V/9-30V

NG09208

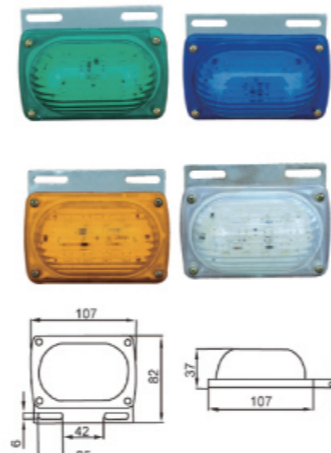

**LED侧标志灯**  
型号: NG09208  
用途: LED具有高亮度、功率低、密封性好、寿命长、100%防水性的特点。  
电压: 24V/12V/9-30V  
Side lamp LED  
Type Number: NG09208  
Description: LED has high brightness, low power, good sealing and long life, 100% waterproof.  
Voltage: 24V/12V/9-30V

NG09209

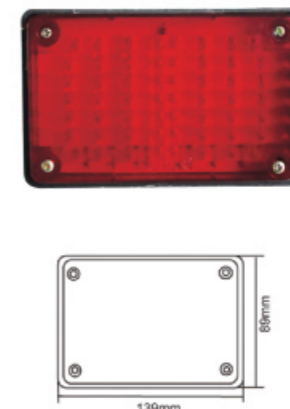

**LED后雾灯**  
型号: NG09209  
用途: LED具有高亮度、功率低、密封性好、寿命长、100%防水性的特点。  
LED数量: 56  
电压: 24V/12V  
Rear Fog lamp LED  
Type Number: NG09209  
Description: LED has high brightness, low power, good sealing and long life, 100% waterproof.  
LED quantity: 56  
Voltage: 24V/12V

### NG09230



#### LED汽车前示廓灯

型号: NG09230  
LED数量: 6  
电压: 24V  
**3C认证产品**  
Front Outline Marker lamp  
Type Number:NG09230  
LED quantity: 6  
Voltage:24V  
**3C Authentication**

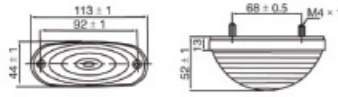

### NG09231



#### LED汽车后示廓灯

型号: NG09231  
LED数量: 6  
电压: 24V  
**3C认证产品**  
Rear Outline Marker lamp  
Type Number:NG09231  
LED quantity: 6  
Voltage:24V  
**3C Authentication**



### NG09216



#### 后组合灯LED

型号: NG09216  
用途: 具有制动/后位、转向灯、后回  
复反射器的功能。采用72颗LED,具有  
超高亮、强耐化学性,100%防水性的  
特点。  
LED数量: 36/36  
电压: 24V/12V/9-30V  
Tail lamp LED  
Type Number:NG09216  
Description: With the functions of shop  
lamp, rear position lamp and turn lamp,  
72 pcs super bright Flux LED with UV  
Polycarbonate lens for enhanced  
chemical resistance 100% waterproof.  
LED quantity:36/36  
Voltage:24V/12V/9-30V



### NG09217



#### 后组合灯LED(灯泡式)

型号: NG09217  
用途: 具有制动/后位、转向灯、牌照灯  
的功能。功率更低、寿命更长、散热性  
好。  
Tail lamp  
Type Number:NG09217  
Description:Power and lower, longer  
service life, good heat dissipation.

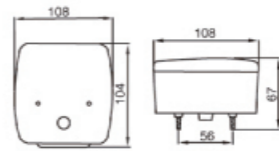

### NG09212



#### 后尾灯LED

型号: NG09212  
用途: 具有后位灯、制动灯、转向灯  
的功能。LED具有高亮度、功率低、  
密封性好、寿命长、100%防水性的  
特点。  
LED数量: 36/36  
电压: 24V/12V  
Tail lamp  
Type Number:NG09212  
Description: LED has high brightness,  
low power, good sealing and long life,  
100% waterproof.  
LED quantity: 36/36  
Voltage: 24V/12V

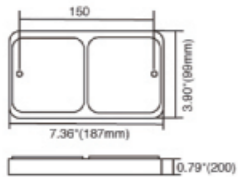

### NG09213



#### 后组合灯LED

型号: NG09213  
用途: 具有制动/后位, 转向灯的功能。  
采用75颗LED,具有超高亮、强耐化学  
性,100%防水性的特点。  
LED数量: 24/24/24  
电压: 24V/12V/9-30V  
**E-mark 认证产品**  
Tail lamp LED  
Type Number:NG09213  
Description: With the functions of shop  
lamp, rear position lamp and turn lamp,  
72 pcs super bright Flux LED with UV  
Polycarbonate lens for enhanced  
chemical resistance 100% waterproof.  
LED quantity: 24/24/24  
Voltage:24V/12V/9-30V  
**E-mark Authentication**

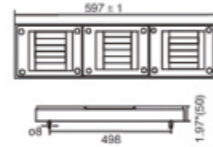

### NG09218



#### 标志灯

型号: NG09218  
用途: 采用2颗LED,具有超高亮、  
强耐化学性,100%防水性的特点。  
LED数量: 2  
**E-mark 认证产品**  
电压: 24V/12V/9-30V  
Marking Lamps LED  
Type Number:NG09218  
Description: 2 pcs super bright Flux  
LED with UV Polycarbonate lens for  
enhanced chemical resistance 100%  
waterproof.  
LED quantity:2  
Voltage:24V/12V/9-30V  
**E-mark Authentication**



### NG09219



#### ABS报警灯

型号: NG09219  
ABS Warning Lamp  
Type Number: NG09219

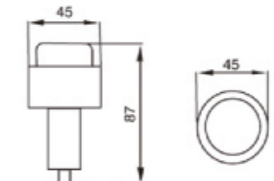

### NG09214



#### 后组合灯LED

型号: NG09214  
用途: 具有制动/后位、转向灯、后回  
复反射器的功能。采用108颗LED,具  
有超高亮、强耐化学性,100%防水性  
的特点。  
LED数量: 36/36/36  
电压: 24V/12V/9-30V  
Tail lamp LED  
Type Number:NG09214  
Description: With the functions of shop  
lamp, rear position lamp and turn lamp,  
108 pcs super bright Flux LED with UV  
Polycarbonate lens for enhanced  
chemical resistance 100% waterproof.  
LED quantity:36/36/36  
Voltage:24V/12V/9-30V

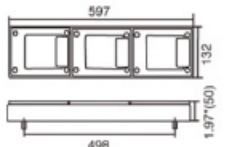

### NG09215



#### 后组合灯LED

型号: NG09215  
用途: 具有制动/后位、转向灯的功能。  
采用48颗LED,具有超高亮、强耐化学  
性,100%防水性的特点。  
LED数量: 24/24  
电压: 24V/12V/9-30V  
**E-mark 认证产品**  
Tail lamp LED  
Type Number:NG09215  
Description: With the functions of shop  
lamp, rear position lamp and turn lamp,  
48 pcs super bright Flux LED with UV  
Polycarbonate lens for enhanced  
chemical resistance 100% waterproof.  
LED quantity:24/24  
Voltage:24V/12V/9-30V  
**E-mark Authentication**



### NG09221

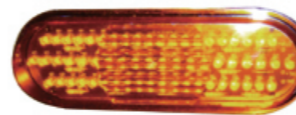

#### LED后尾灯

型号: NG09221 (原NG09221-1)  
用途: LED具有高亮度、功率低、  
密封性好、寿命长,100%防水性的  
特点。  
LED数量: 45  
电压: 12V/24V  
Tail Lamp LED  
Type Number:NG09221  
Application:LED has high brightness,  
low power, good sealing and long life,  
100% waterproof.  
LED quantity:45  
Voltage:12V/24V

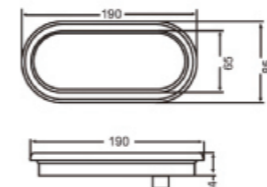

### NG09223



#### LED后尾灯

型号: NG09223 (原NG09223-2)  
用途: LED具有高亮度、功率低、  
密封性好、寿命长,100%防水性的  
特点。  
LED数量: 60  
电压: 12V/24V  
Tail Lamp LED  
Type Number:NG09223  
Application:LED has high brightness,  
low power, good sealing and long life,  
100% waterproof.  
LED quantity:60  
Voltage:12V/24V

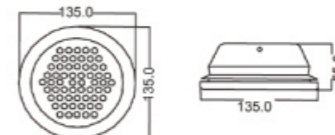

NG09224

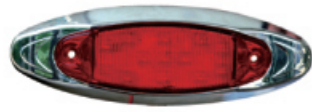

LED后尾灯

型号: NG09224  
用途: LED具有高亮度、功率低、密封性好、寿命长, 100%防水性的特点。  
LED数量: 13  
电压: 12V/24V/9-30V  
Tail Lamp LED  
Type Number:NG09224  
Application:LED has high brightness, low power,good sealing and long life, 100% waterproof.  
LED quantity:13  
Voltage:12V/24V/9-30V

NG09225

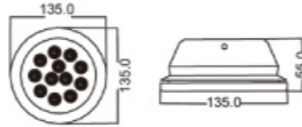

LED后尾灯

型号: NG09225 (原NG09225-2)  
用途: LED具有高亮度、功率低、密封性好、寿命长, 100%防水性的特点。  
LED数量: 12  
电压: 24V/12V/9-30V  
Tail Lamp LED  
Type Number:NG09225  
Application:LED has high brightness, low power,good sealing and long life, 100% waterproof.  
LED quantity:12  
Voltage:24V/12V/9-30V

NG09225-1

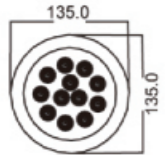
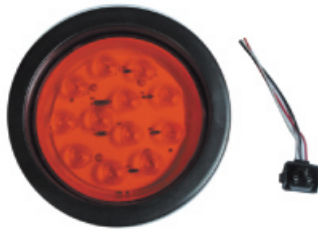

LED后尾灯

型号: NG09225-1  
用途: LED具有高亮度、功率低、密封性好、寿命长, 100%防水性的特点。  
LED数量: 12  
电压: 24V/12V/9-30V  
Tail Lamp LED  
Type Number:NG09225  
Application:LED has high brightness, low power,good sealing and long life, 100% waterproof.  
LED quantity:12  
Voltage:24V/12V/9-30V

NG09226



后组合灯

型号: NG09226  
用途: 具有倒车/转向/后位/制动的功能  
灯泡型号: P21/5W(24V21/5W)  
Tail Lamps  
Type Number:NG09226  
Application:With the functions of Trun lamp Rear position lamp and Backup lamp.  
Bulb Mode:P21/5W(24V21/5W)

NG09226-1



6寸椭圆灯(泡式)

型号: NG09226-1  
用途: 侧转向灯、侧标志灯、侧反射器  
6" Ellipse Lamp  
Type Number:NG09226-1  
Application:With the functions of side Turn lamp , side signal lamp and side reflector.

NG09227-1

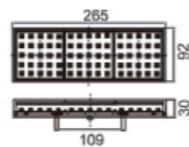

后组合灯LED

型号: NG09227-1  
用途: 具有制动、后位、倒车、转向灯的功能。LED具有高亮度、功率低、密封性好、寿命长、100%防水性的特点。  
LED数量: 25/25/25  
电压: 12/24V/9-30V  
E-mark/3C认证产品  
Tail Lamp LED  
Description:With the functions of stop lamp,Rear position lamp and turn lamp.LED has brightness,Low power, good sealing and long life 100% waterproof.  
LED quantity: 25/25/25  
Voltage: 12/24V/9-30V  
E-mark /3CAuthentication

NG09227-2

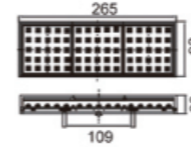

后组合灯LED

型号: NG09227-2  
用途: 具有制动、后位、后雾、转向灯的功能。LED具有高亮度、功率低、密封性好、寿命长、100%防水性的特点。  
LED数量: 25/25/25  
电压: 12/24V/9-30V  
E-mark认证产品  
Tail Lamp LED  
Description:With the functions of stop lamp,Rear position lamp and turn lamp.LED has brightness,Low power, good sealing and long life 100% waterproof.  
LED quantity: 25/25/25  
Voltage: 12/24V/9-30V  
E-mark Authentication

NG09227-4

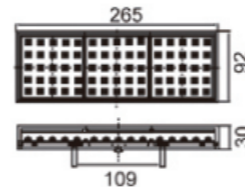

后组合灯LED

型号: NG09227-4  
用途: 具有制动、后位、后雾、转向灯的功能。LED具有高亮度、功率低、密封性好、寿命长、100%防水性的特点。  
LED数量: 20/20/20  
电压: 12/24V/9-30V  
E-mark认证产品  
Tail Lamp LED  
Description:With the functions of stop lamp,Rear position lamp and turn lamp.LED has brightness,Low power, good sealing and long life 100% waterproof.  
LED quantity: 20/20/20  
Voltage: 12/24V/9-30V  
E-mark Authentication

NG09228

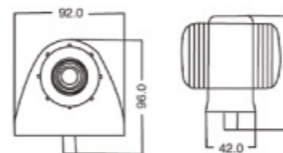

双面灯

型号: NG09228 (原NG02020-1)  
用途: LED具有高亮度、功率低、密封性好、寿命长、100%防水性的特点。  
LED数量: 6/6  
电压: 12/24V/9-30V  
Double Face LED  
Type Number:NG09228  
Description:LED has brightness,Low power,good sealing and long life 100% waterproof.  
LED quantity: 6/6  
Voltage: 12/24V/9-30V

NG09227-3

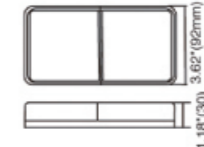
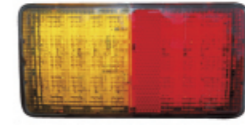
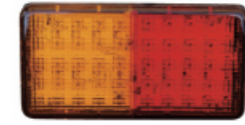

后组合灯LED

型号: NG09227-3  
用途: 具有制动、后位、转向灯的功能。LED具有高亮度、功率低、密封性好、寿命长、100%防水性的特点。  
LED数量: 25/25  
电压: 12/24V/9-30V  
E-mark认证产品  
Tail Lamp LED  
Description:With the functions of stop lamp,Rear position lamp and turn lamp.LED has brightness,Low power, good sealing and long life 100% waterproof.  
LED quantity: 25/25  
Voltage: 12/24V/9-30V  
E-mark Authentication

NG09227-5

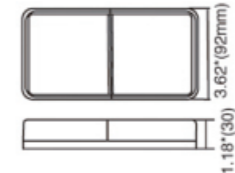
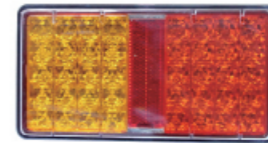

后组合灯LED

型号: NG09227-5  
用途: 具有制动、后位、转向灯的功能。LED具有高亮度、功率低、密封性好、寿命长、100%防水性的特点。  
LED数量: 20/20  
电压: 12/24V/9-30V  
E-mark认证产品  
Tail Lamp LED  
Description:With the functions of stop lamp,Rear position lamp and turn lamp.LED has brightness,Low power, good sealing and long life 100% waterproof.  
LED quantity: 20/20  
Voltage: 12/24V/9-30V  
E-mark Authentication

NG09233

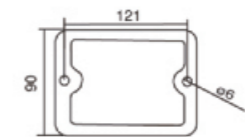

LED后尾灯

型号: NG09233  
描述: LED具有高亮度、功率低、密封性好、寿命长、100%防水性的特点。  
LED数量: 12/18  
电压: 12/24V/9-30V  
E-mark认证产品  
Tail Lamp LED  
Type Number: NG09233  
Description:LED has brightness, Low power,good sealing and long life 100% waterproof.  
LED quantity: 12/18  
Voltage: 12/24V/9-30V  
E-mark Authentication

NG09233-1

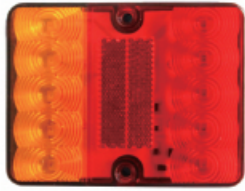

LED后尾灯

型号: NG09233-1  
描述: LED具有高亮度、功率低、密封性好、寿命长、100%防水性。  
LED数量: 5/5  
电压: 12/24V/9-30V  
E-mark认证产品  
Tail Lamp LED  
Type Number: NG09233-1  
Description: LED has brightness, Low power, good sealing and long life 100% waterproof.  
LED quantity: 5/5  
Voltage: 12/24V/9-30V  
E-mark Authentication

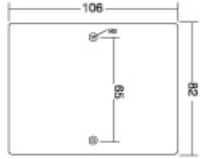

NG09301



后组合灯LED

型号: NG09301  
描述: 转向灯、倒车灯、后雾灯、制动/后位灯(带爆闪)、牌照灯。LED具有高亮度、功率低、密封性好、寿命长、100%防水性的特点。  
LED数量: 115/109 电压: 24V/12V  
Tail Lamp LED  
Type Number: NG09301  
Description: With the functions of the Turn lamp, Backup lamp, stop & Rear position lamp (flash explosion). LED has high brightness, low power, good sealing and long life, 100% waterproof.  
LED quantity: 115/109  
Voltage: 12V/24V

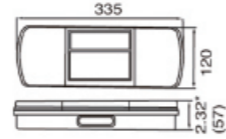

NG09306



后组合灯LED

型号: NG09306  
描述: 转向灯、倒车灯、制动/后位灯的功能, LED具有高亮度、功率低、密封性好、寿命长, 100%防水性的特点。  
LED数量: 60 电压: 24V/12V  
Tail Lamp LED  
Type Number: NG09306  
Description: With the functions of the Turn lamp, Backup lamp, stop & Rear position lamp. LED has high brightness, low power, good sealing and long life, 100% waterproof.  
LED quantity: 60  
Voltage: 24V/12V

NG09302



后组合灯LED

型号: NG09302  
描述: 转向灯、倒车灯、后雾灯、制动/后位灯(带爆闪)、牌照灯。LED具有高亮度、功率低、密封性好、寿命长, 100%防水性的特点。  
LED数量: 144/150 电压: 24V/12V  
Tail Lamp LED  
Type Number: NG09302  
Description: With the functions of the Turn lamp, Backup lamp, stop & Rear position lamp (flash explosion). LED has high brightness, low power, good sealing and long life, 100% waterproof.  
LED quantity: 144/150  
Voltage: 24V/12V

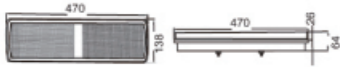

NG09303

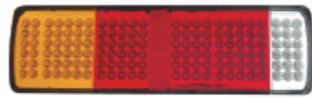

后组合灯LED

型号: NG09303  
描述: 转向灯、倒车灯、后雾灯、制动/后位灯(带爆闪)、牌照灯。LED具有高亮度、功率低、密封性好、寿命长, 100%防水性的特点。  
LED数量: 144/150 电压: 24V/12V  
Tail Lamp LED  
Type Number: NG09303  
Description: With the functions of the Turn lamp, Backup lamp, stop & Rear position lamp (flash explosion). LED has high brightness, low power, good sealing and long life, 100% waterproof.  
LED quantity: 144/150  
Voltage: 24V/12V



NG09304



后组合灯LED

型号: NG09304  
描述: 转向灯、倒车灯、后雾灯、制动/后位灯。LED具有高亮度、功率低、密封性好、寿命长, 100%防水性的特点。  
LED数量: 96 电压: 24V/12V  
Tail Lamp LED  
Type Number: NG09304  
Description: With the functions of the Turn lamp, Backup lamp, stop & Rear position lamp. LED has high brightness, low power, good sealing and long life, 100% waterproof.  
LED quantity: 96  
Voltage: 24V/12V

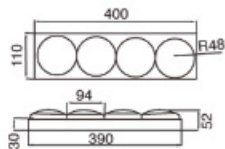

NG09305



后组合灯LED

型号: NG09305  
描述: 转向灯、倒车灯、后雾灯、制动/后位灯。LED具有高亮度、功率低、密封性好、寿命长, 100%防水性的特点。  
LED数量: 120 电压: 24V/12V  
Tail Lamp LED  
Type Number: NG09305  
Description: With the functions of the Turn lamp, Backup lamp, stop & Rear position lamp. LED has high brightness, low power, good sealing and long life, 100% waterproof.  
LED quantity: 120  
Voltage: 24V/12V

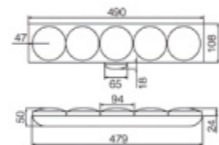

NG11001



LED后尾灯

型号: NG11001 (由NG09234组成)  
描述: LED具有高亮度、功率低、密封性好、寿命长, 100%防水性的特点。

LED数量: 10 电压: 24V

E-mark认证产品

Tail Lamp LED

Type Number:NG11001

Description:LED has high brightness, low power,good sealing and long life, 100% waterproof.

LED quantity:10

Voltage:24V

E-mark Authentication

NG09234

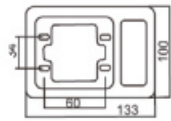

NG11003



LED后尾灯

型号: NG11003  
(由NG09234/235/236组成)

描述: LED具有高亮度、功率低、密封性好、寿命长, 100%防水性的特点。

LED数量: 10/10/10 电压: 24V

E-mark认证产品

Tail Lamp LED

Type Number:NG11003

Description:LED has high brightness, low power,good sealing and long life, 100% waterproof.

LED quantity:10/10/10

Voltage:24V

E-mark Authentication

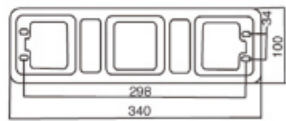

NG11002



后组合灯LED

型号: NG11002  
(由NG09234/235组成)

描述: LED具有高亮度、功率低、密封性好、寿命长, 100%防水性的特点。

LED数量: 10/10 电压: 24V

E-mark认证产品

Tail Lamp LED

Type Number:NG11002

Description:LED has high brightness, low power,good sealing and long life, 100% waterproof.

LED quantity:10/10

Voltage:24V

E-mark Authentication

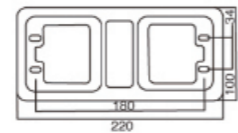
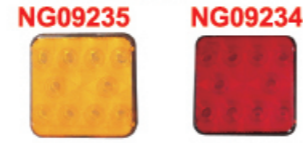

NG11007

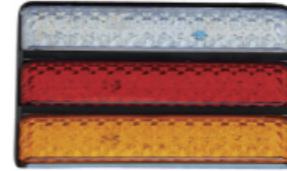

LED后尾灯

型号: NG11007

描述: LED具有高亮度、功率低、密封性好、寿命长, 100%防水性的特点。

LED数量: 36/36/36

电压: 24V/12V

Tail Lamp LED

Type Number:NG11007

Description:LED has high brightness, low power,good sealing and long life, 100% waterproof.

LED quantity: 36/36/36

Voltage:12V/24V

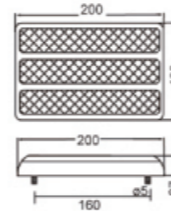

NG11008



后组合灯LED

型号: NG11008 (原NG01014-1)  
描述: LED具有高亮度、功率低、密封性好、寿命长, 100%防水性的特点。

LED数量: 40

电压: 24V/12V/9-30V

Tail Lamp LED

Type Number:NG11008

Description:LED has high brightness, low power,good sealing and long life, 100% waterproof.

LED quantity:40

Voltage:24V/12V/9-30V

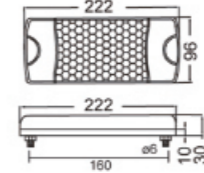

NG11009



后组合灯LED

型号: NG11009(原NG09221-3)

描述: LED具有高亮度、功率低、密封性好、寿命长, 100%防水性的特点。

LED数量: 20/20

电压: 24V/12V/9-30V

Tail Lamp LED

Type Number:NG11009

Description:LED has high brightness, low power,good sealing and long life, 100% waterproof.

LED quantity:20/20

Voltage:24V/12V/9-30V

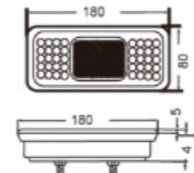

NG11010

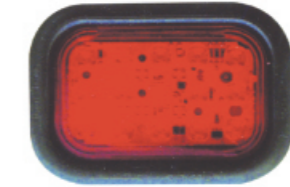

LED后尾灯

型号: NG11010(原NG09223-1)

描述: LED具有高亮度、功率低、密封性好、寿命长, 100%防水性的特点。

电压: 24V

Tail Lamp LED

Type Number:NG11010

Description:LED has high brightness, low power,good sealing and long life, 100% waterproof.

Voltage:24V

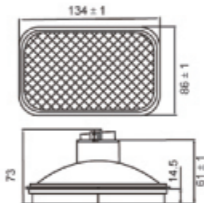

NG11005(W/R/Y)



LED后尾灯

型号: NG11005 ( W/R/Y )

用途: LED具有高亮度、功率低、密封性好、寿命长, 100%防水性的特点。

LED数量: 6/6

电压: 12/24V

Tail Lamp

Type Number:NG11005 ( W/R/Y )

Description:LED has brightness,Low power,good sealing and long life 100% waterproof.

LED quantity: 6/6

Voltage: 12/24V

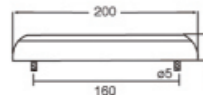
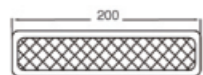

NG11006



LED后尾灯

型号: NG11006(原NG10003-3)

描述: LED具有高亮度、功率低、密封性好、寿命长, 100%防水性的特点。

LED数量: 36/36

电压: 12/24V

Tail Lamp LED

Type Number: NG09233

Description:LED has brightness, Low power,good sealing and long life 100% waterproof.

LED quantity: 36/36

Voltage: 12/24V

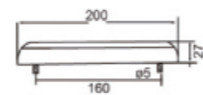
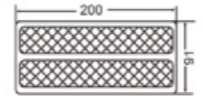

NG11011



LED后尾灯

型号: NG11011(原NG01011-2)

开孔尺寸: 20.5

描述: LED具有高亮度、功率低、密封性好、寿命长, 100%防水性的特点。

电压: 24V/12V

Tail Lamp LED

Type Number:NG11011

Description:LED has high brightness, low power,good sealing and long life, 100% waterproof.

Voltage:24V/12V

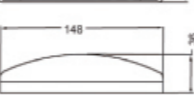
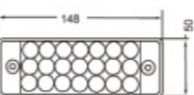

NG11012



LED后尾灯

型号: NG11012

描述: 具有制动/后位、转向、牌照灯、后回复反射器功能。LED具有高亮度、功率低、密封性好、寿命长, 100%防水性的特点。

LED数量: 20/20/4 电压: 24V/12V

Tail Lamp LED

Type Number:NG11012

Description:LED has high brightness, low power,good sealing and long life, 100% waterproof.

LED quantity:20/20/4

Voltage:24V/12V

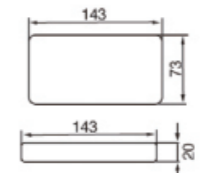

NG11013



LED后尾灯

型号: NG11013  
描述: 具有制动/后位、转向、倒车的功能。LED具有高亮度、功率低、密封性好、寿命长, 100%防水性的特点。  
LED数量: 8/8/5 电压: 24V/12V  
Tail Lamp LED  
Type Number:NG11013  
Description:LED has high brightness, low power,good sealing and long life, 100% waterproof.  
LED quantity: 8/8/5  
Voltage:24V/12V

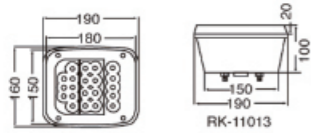

NG11014



LED后尾灯

型号: NG11014  
描述: LED具有高亮度、功率低、密封性好、寿命长, 100%防水性的特点。  
LED数量: 12/4 电压: 24V/12V  
Tail Lamp LED  
Type Number:NG11014  
Description:LED has high brightness, low power,good sealing and long life, 100% waterproof.  
LED quantity: 12/4  
Voltage:24V/12V



NG11019



LED后尾灯(爆闪)

型号: NG11019  
描述: LED具有高亮度、功率低、密封性好、寿命长, 100%防水性的特点。  
LED数量: 29  
电压: 24V/12V  
Tail Lamp LED  
Type Number:NG11009  
Description:LED has high brightness, low power,good sealing and long life, 100% waterproof.  
LED quantity: 29  
Voltage:12V/24V

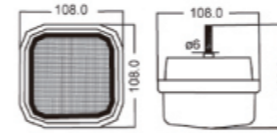

NG11020



LED后尾灯(爆闪)

型号: NG11020  
描述: LED具有高亮度、功率低、密封性好、寿命长, 100%防水性的特点。  
LED数量: 32  
电压: 24V/12V  
Tail Lamp LED  
Type Number:NG11020  
Description:LED has high brightness, low power,good sealing and long life, 100% waterproof.  
LED quantity: 32  
Voltage:12V/24V

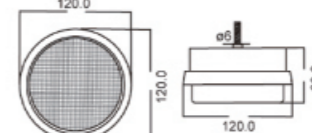

NG11015



LED后尾灯

型号: NG11015(原NG0926-1)  
描述: LED具有高亮度、功率低、密封性好、寿命长, 100%防水性的特点。  
LED数量: 10  
电压: 12V/24V  
Tail Lamp LED  
Type Number:NG11015  
Description:LED has high brightness, low power,good sealing and long life, 100% waterproof.  
LED quantity:10  
Voltage:12V/24V

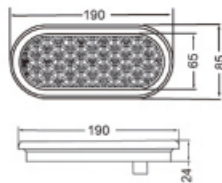

NG11016



LED后尾灯

型号: NG11016  
描述: 转向、后位、制动的功能。LED具有高亮度、功率低、密封性好、寿命长, 100%防水性的特点。  
LED数量: 36  
电压: 24V  
Tail Lamp LED  
Type Number:NG11016  
Description:LED has high brightness, low power,good sealing and long life, 100% waterproof.  
LED quantity:36  
Voltage:24V

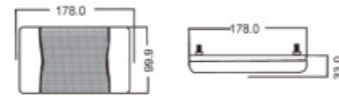

NG11021



LED后尾灯

型号: NG11021  
描述: 制动/后位/侧标志/侧回复/后反射器功能, LED具有高亮度、功率低、密封性好、寿命长, 100%防水性的特点。  
LED数量: 12/4/4  
电压: 12V/24V  
Tail Lamp LED  
Type Number:NG11021  
Description:LED has high brightness, low power,good sealing and long life, 100% waterproof.  
LED quantity:12/4/4  
Voltage:12V/24V

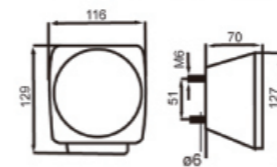

NG11022



LED后尾灯

型号: NG11022  
描述: 制动灯/后位灯/侧标志/侧回复/后反射器功能, LED具有高亮度、功率低、密封性好、寿命长, 100%防水性的特点。  
LED数量: 12/4/4  
电压: 12V/24V  
Tail Lamp LED  
Type Number:NG11022  
Description:LED has high brightness, low power,good sealing and long life, 100% waterproof.  
LED quantity:12/4/4  
Voltage:12V/24V

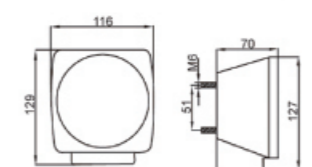

NG11017



LED后尾灯

型号: NG11017  
用途: LED具有高亮度、功率低、密封性好、寿命长, 100%防水性的特点。  
LED数量: 10  
电压: 12/24V/9-30V  
Tail Lamp LED  
Type Number:NG11017  
Description:LED has brightness,Low power,good sealing and long life 100% waterproof.  
LED quantity: 10  
Voltage: 12/24V

NG11018



LED后尾灯

型号: NG11018(原NG10004-1)  
描述: 制动/后位、转向、后回复反射器的功能, LED具有高亮度、功率低、密封性好、寿命长, 100%防水性的特点。  
LED数量: 7/7  
电压: 12/24V/9-30V  
Tail Lamp LED  
Type Number: NG11018  
Description:LED has brightness, Low power,good sealing and long life 100% waterproof.  
LED quantity: 7/7  
Voltage: 12/24V/9-30V

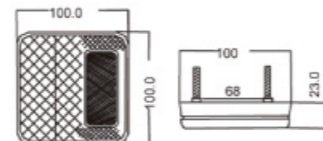

NG11023

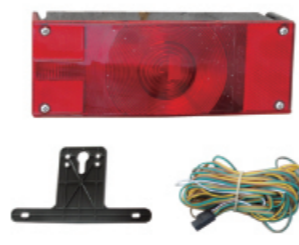

LED后尾灯

型号: NG11023  
描述: LED具有高亮度、功率低、密封性好、寿命长, 100%防水性的特点。  
电压: 12V/24V  
Tail Lamp LED  
Type Number:NG11023  
Description:LED has high brightness, low power,good sealing and long life, 100% waterproof.  
Voltage:12V/24V

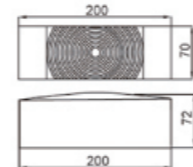

NG11024



LED后尾灯

型号: NG11024  
描述: 制LED具有高亮度、功率低、密封性好、寿命长, 100%防水性的特点。  
LED数量: 7  
电压: 12V/24V  
Tail Lamp LED  
Type Number:NG11024  
Description:LED has high brightness, low power,good sealing and long life, 100% waterproof.  
LED quantity:7  
Voltage:12V/24V

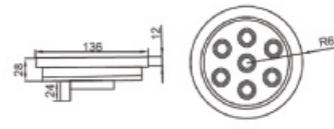

NG11025



LED后尾灯

型号: NG11025  
描述: LED具有高亮度、功率低、密封性好、寿命长, 100%防水性的特点。  
LED数量: 10  
电压: 12V/24V  
Tail Lamp LED  
Type Number:NG11025  
Description:LED has high brightness, low power,good sealing and long life, 100% waterproof.  
LED quantity: 10  
Voltage:12V/24V

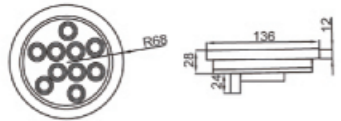

NG11025-1



型号: NG11025-1 (泡式)  
Type Number:NG11025-1

NG11026



LED后尾灯

型号: NG11026  
描述: LED具有高亮度、功率低、密封性好、寿命长, 100%防水性的特点。  
LED数量: 7  
电压: 12V/24V  
Tail Lamp LED  
Type Number:NG11026  
Description:LED has high brightness, low power,good sealing and long life, 100% waterproof.  
LED quantity:7  
Voltage:12V/24V

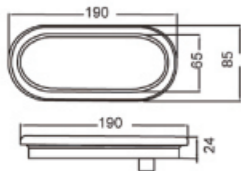

NG11027



LED后尾灯

型号: NG11027  
描述: LED具有高亮度、功率低、密封性好、寿命长, 100%防水性的特点。  
LED数量: 10  
电压: 12V/24V  
Tail Lamp LED  
Type Number:NG11027  
Description:LED has high brightness, low power,good sealing and long life, 100% waterproof.  
LED quantity:10  
Voltage:12V/24V

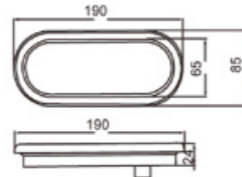

NG11028



后尾灯(灯泡)

型号: NG11028  
用途: 具有转向灯/制动灯/后位灯/倒车灯/前后示廓灯/后回复反射器/后雾灯的功能  
灯泡型号: P21W(24V21W)  
P21/5W(24V21/5W)  
Tail Lamp  
Type Number:NG11028  
Appliction:With the steering lamp/Lighth/Rear Position lamp/Reversing lamp/Rear end-outline marker lamp/Retro-reflecting device function.  
Bulb Mode: P21W(24V21W)  
P21/5W(24V21/5W)

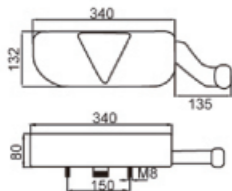

NG11029



后尾灯(灯泡)

型号: NG11029  
用途: 具有转向灯/制动灯/后位灯/倒车灯/侧标示/侧回复/后回复反射器/后雾灯的功能  
灯泡型号: P21W(24V21W)  
P21/5W(24V21/5W)  
Tail Lamp  
Type Number:NG11029  
Appliction:With the steering lamp/Lighth/Rear Position lamp/Reversing lamp/Side Label/Side back/Retro-reflecting device function.  
Bulb Mode: P21W(24V21W)  
P21/5W(24V21/5W)



NG11033



后尾灯(灯泡)

型号: NG11033  
用途: 具有转向灯/制动灯/后位灯/倒车灯的功能。  
灯泡型号: P21W(21V/21W)  
P21/5W(21V/21/5W)  
Tail Lamp  
Type Number:NG11033  
Appliction:With braking lamp/light/Reversing lamp function.  
Bulb Mode: P21W(21V/21W)  
P21/5W(21V/21/5W)

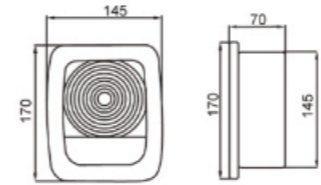

NG11034



后尾灯(灯泡)

型号: NG11034  
用途: 具有转向灯/制动灯/后位灯/牌照灯的功能。  
灯泡型号: P21W(21V/21W)  
P21/5W(21V/21/5W)  
Tail Lamp  
Type Number:NG11034  
Appliction:With the steering lamp/light/Rear position lamp/license plate lamp function.  
Bulb Mode: P21W(21V/21W)  
P21/5W(21V/21/5W)



NG11036



后尾灯(灯泡)

型号: NG11036  
灯泡型号: P21W(21V/21W)  
P21/5W(21V/21/5W)  
Tail Lamp  
Type Number:NG11036  
Bulb Mode: P21W(21V/21W)  
P21/5W(21V/21/5W)

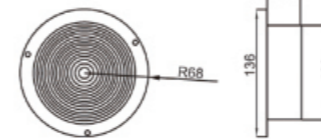

NG11037



后尾灯(灯泡)

型号: NG11037  
用途: 具有制动灯/后位灯/牌照灯的功能。  
灯泡型号: P21W(21V/21W)  
P21/5W(21V/21/5W)  
Tail Lamp  
Type Number:NG11037  
Appliction:With the light/Rear position lamp/license plate lamp function.  
Bulb Mode: P21W(21V/21W)  
P21/5W(21V/21/5W)

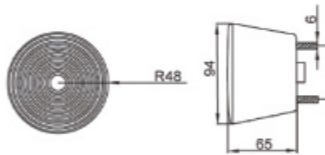

NG11038



后尾灯(灯泡)

型号: NG11038  
用途: 具有制动灯/后位灯/侧标志灯/侧回复/后回复反射器的功能。  
灯泡型号: P21W(21V/21W)  
P21/5W(21V/21/5W)  
Tail Lamp  
Type Number:NG11038  
Appliction:Having a brake/rear,side marker,side,rear-reflecting devices function.  
Bulb Mode: P21W(21V/21W)  
P21/5W(21V/21/5W)

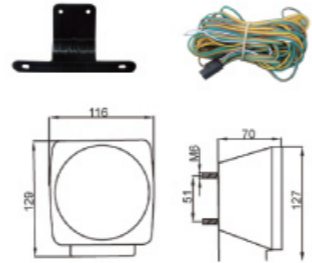

NG11039



后尾灯(灯泡)

型号: NG11039  
用途: 具有制动灯/后位灯/侧标志灯/侧回复/后回复反射器的功能。  
灯泡型号: P21W(21V/21W)  
P21/5W(21V/21/5W)  
Tail Lamp  
Type Number:NG11039  
Appliction:Having a brake/rear,side marker,side,rear retro-reflecting devices function.  
Bulb Mode: P21W(21V/21W)  
P21/5W(21V/21/5W)

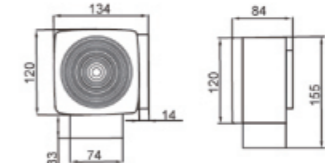

### NG11040



#### 后尾灯(灯泡)

型号: NG11040  
用途: 具有制动灯/后位灯/转向灯/倒车灯/后回复反射器的功能。  
灯泡型号: P21W(21V/21W)  
P21/5W(21V/21/5W)

Tail Lamp  
Type Number:NG11040  
Applction:Having a brake/rear, Position,Steering/reflectiong,retro-devices function.  
Bulb Mode: P21W(21V/21W)  
P21/5W(21V/21/5W)

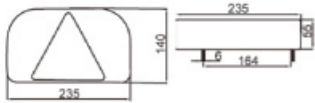

### NG11041



#### 后尾灯(灯泡)

型号: NG11041  
用途: 具有制动灯/后位灯/转向灯/倒车灯/后雾灯/后回复反射器的功能。  
灯泡型号: P21W(21V/21W)  
P21/5W(21V/21/5W)

Tail Lamp  
Type Number:NG11041  
Applction:Having a brake/rear, Position,Steering/reflectiong,retro-devices function.  
Bulb Mode: P21W(21V/21W)  
P21/5W(21V/21/5W)

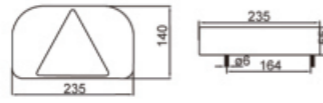

### NG11042



#### 后尾灯(灯泡)

型号: NG11042  
用途: 具有制动灯/后位灯/转向灯/倒车灯/后雾灯/后回复反射器的功能。  
灯泡型号: P21W(21V/21W)  
P21/5W(21V/21/5W)

Tail Lamp  
Type Number:NG11042  
Applction:Having a brake/rear, Position,Steering/reflectiong,retro-devices function.  
Bulb Mode: P21W(21V/21W)  
P21/5W(21V/21/5W)

### NG11043



#### 后尾灯(灯泡)

型号: NG11043  
用途: 具有制动灯/后位灯/转向灯/倒车灯/后雾灯/前后示廓灯/后回复反射器的功能。  
灯泡型号: P21W(21V/21W)  
P21/5W(21V/21/5W)

Tail Lamp  
Type Number:NG11043  
Applction:Having a brake/rear, Position,Steering/reflectiong,front a rearedng-outline marker/retro-reflectingdevices function.  
Bulb Mode: P21W(21V/21W)  
P21/5W(21V/21/5W)

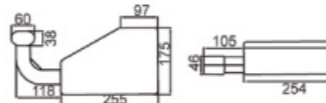

### NG11044



#### 示廓灯LED

型号: NG11044  
描述: 采用6颗LED, 具有高亮度、超高亮度、强耐化学性, 100%防水性的特点。  
LED数量: 6  
电压: 24V  
Tail Lamp LED  
Type Number:NG11044  
Description:6 pcs super bright LED with UV Polycarbonate les for enhanced chemical Resistance 100% waterproof.  
LED quantity:6  
Voltage:24V

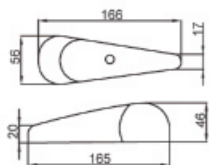

### NG11045 L/R



#### LED后尾灯

型号: NG11045 L/R  
描述: 转向灯/后位灯/制动灯/后回复反射器的功能。LED具有高亮度、功率低、密封性好、寿命长, 100%防水性的特点。  
LED数量: 5/5  
电压: 12V/24V/10-30V  
E-mark认证产品  
Tail Lamp LED  
Type Number:NG11045 L/R  
Description:LED has high brightness, low power,good sealing and long life, 100% waterproof.  
LED quantity:5/5  
Voltage:12V/24V/10-30V  
E-mark Authentication

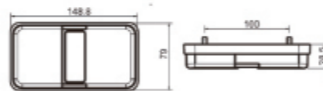

### NG11046 L/R



#### LED后尾灯

型号: NG11046 L/R  
描述: 转向灯/后位灯/制动灯/后回复反射器的功能。LED具有高亮度、功率低、密封性好、寿命长, 100%防水性的特点。  
LED数量: 10/10  
电压: 12V/24V/10-30V  
E-mark认证产品  
Tail Lamp LED  
Type Number:NG11046 L/R  
Description:LED has high brightness, low power,good sealing and long life, 100% waterproof.  
LED quantity:10/10  
Voltage:12V/24V/10-30V  
E-mark Authentication

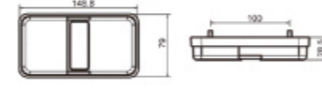

### NG11047 L/R



#### LED后尾灯

型号: NG11047 L/R  
描述: 转向灯/后位灯/制动灯/后回复反射器的功能。LED具有高亮度、功率低、密封性好、寿命长, 100%防水性的特点。  
LED数量: 5/5  
电压: 12V/24V/10-30V  
E-mark认证产品  
Tail Lamp LED  
Type Number:NG11047 L/R  
Description:LED has high brightness, low power,good sealing and long life, 100% waterproof.  
LED quantity:5/5  
Voltage:12V/24V/10-30V  
E-mark Authentication

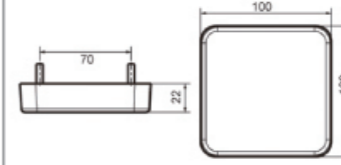

### NG11047-1 L/R



#### LED后尾灯

型号: NG11047-1 L/R  
描述: 转向灯/后位灯/制动灯/牌照灯、后回复反射器的功能。LED具有高亮度、功率低、密封性好、寿命长, 100%防水性的特点。  
LED数量: 5/5  
电压: 12V/24V/10-30V  
E-mark认证产品  
Tail Lamp LED  
Type Number:NG11047-1 L/R  
Description:LED has high brightness, low power,good sealing and long life, 100% waterproof.  
LED quantity:5/5  
Voltage:12V/24V/10-30V  
E-mark Authentication

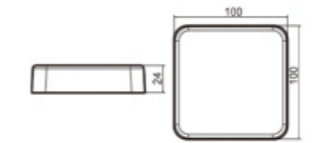

### NG11048 L/R



#### LED后尾灯

型号: NG11048 L/R  
描述: 转向灯/后位灯/制动灯/后回复反射器的功能。LED具有高亮度、功率低、密封性好、寿命长, 100%防水性的特点。  
LED数量: 6/6  
电压: 12V/24V/10-30V  
E-mark认证产品  
Tail Lamp LED  
Type Number:NG11048 L/R  
Description:LED has high brightness, low power,good sealing and long life, 100% waterproof.  
LED quantity:6/6  
Voltage:12V/24V/10-30V  
E-mark Authentication



### NG11049 L/R



#### LED后尾灯

型号: NG11049 L/R  
描述: 转向灯/后位灯/制动灯/牌照灯/后回复反射器的功能。LED具有高亮度、功率低、密封性好、寿命长, 100%防水性的特点。  
LED数量: 8/8/4  
电压: 12V/24V/10-30V  
E-mark认证产品  
Tail Lamp LED  
Type Number:NG11049 L/R  
Description:LED has high brightness, low power,good sealing and long life, 100% waterproof.  
LED quantity:8/8/4  
Voltage:12V/24V/10-30V  
E-mark Authentication

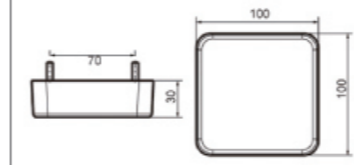

### NG11050

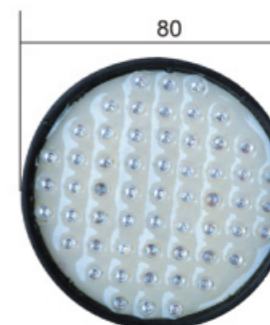

#### LED后尾灯

型号: NG11050  
描述: 后位灯/制动灯功能。LED具有高亮度、功率低、密封性好、寿命长, 100%防水性的特点。  
LED数量: 57  
电压: 12V/24V  
Tail Lamp LED  
Type Number:NG11050  
Description:LED has high brightness, low power,good sealing and long life, 100% waterproof.  
LED quantity:57  
Voltage:12V/24V

NG11051



后尾灯(灯泡)

型号: NG11051  
用途: 具有制动灯/后位灯/转向灯  
后雾灯/倒车灯/侧标志灯的功能。  
Tail Lamp  
Type Number:NG11051  
Applction:Have brake lamp/rear  
light/turn on lamp The function of  
the following fog lamp/headlamp/side  
marker lamp.

NG11052



LED后尾灯

型号: NG11052  
描述: 后位灯/制动灯/转向灯/牌照灯、  
后回复反射器的功能。LED具有高亮  
度、功率低、密封性好、寿命长、  
100%防水性的特点。  
LED数量: 5/5  
电压: 12V/24V/9-30V  
E-mark认证产品  
Tail Lamp LED  
Type Number:NG11052  
Description:LED has high brightness,  
low power,good sealing and long life,  
100% waterproof.  
LED quantity:5/5  
Voltage:12V/24V/9-30V  
E-mark Authentication

NG12004-1



LED侧标志灯(2.5寸)

型号: NG12004-1  
描述: LED具有高亮度、功率低、  
密封性好、寿命长、100%防水性  
的特点。  
LED数量: 6  
电压: 12V/24V  
2.5" Side Lamp LED  
Type Number:NG12004-1  
Description:LED has high brightness,  
low power,good sealing and long life,  
100% waterproof.  
LED quantity:6  
Voltage:12V/24V

NG12005

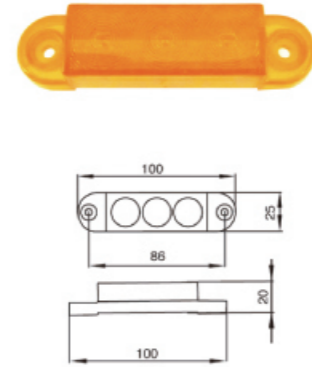

LED侧标志灯

型号: NG12005  
描述: LED具有高亮度、功率低、  
密封性好、寿命长、100%防水性  
的特点。  
LED数量: 3  
电压: 12V/24V  
Side Lamp LED  
Type Number:NG12005  
Description:LED has high brightness,  
low power,good sealing and long life,  
100% waterproof.  
LED quantity:3  
Voltage:12V/24V

NG12001



LED侧标志灯(1寸)

型号: NG12001  
描述: LED具有高亮度、功率低、  
密封性好、寿命长、100%防水性  
的特点。  
LED数量: 3  
电压: 12V/24V  
1" Side Lamp LED  
Type Number:NG12001  
Description:LED has high brightness,  
low power,good sealing and long life,  
100% waterproof.  
LED quantity:3  
Voltage:12V/24V

NG12002



LED侧标志灯(1.5寸)

型号: NG12002  
描述: LED具有高亮度、功率低、  
密封性好、寿命长、100%防水性  
的特点。  
LED数量: 5  
电压: 12V/24V  
1.5" Side Lamp LED  
Type Number:NG12002  
Description:LED has high brightness,  
low power,good sealing and long life,  
100% waterproof.  
LED quantity:5  
Voltage:12V/24V

NG12006

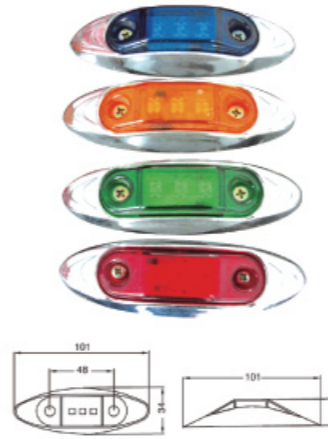

LED侧标志灯

型号: NG12006(原NG09230-1)  
描述: LED具有高亮度、功率低、  
密封性好、寿命长、100%防水性  
的特点。  
LED数量: 3  
电压: 12V/24V  
Side Lamp LED  
Type Number:NG12006  
Description:LED has high brightness,  
low power,good sealing and long life,  
100% waterproof.  
LED quantity:3  
Voltage:12V/24V

NG12007



LED侧标志灯

型号: NG12007(原NG07005)  
描述: LED具有高亮度、功率低、  
密封性好、寿命长、100%防水性  
的特点。  
LED数量: 10  
电压: 12V/24V/9-30V  
Side Lamp LED  
Type Number:NG12007  
Description:LED has high brightness,  
low power,good sealing and long life,  
100% waterproof.  
LED quantity:10  
Voltage:12V/24V/9-30V

NG12003

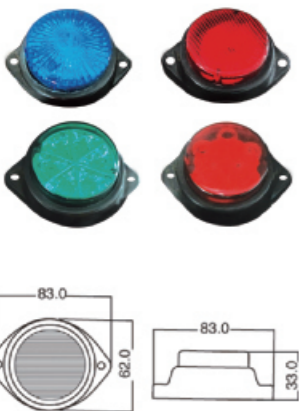

LED侧标志灯(2寸)

型号: NG12003  
描述: LED具有高亮度、功率低、  
密封性好、寿命长、100%防水性  
的特点。  
LED数量: 6  
电压: 12V/24V  
2" Side Lamp LED  
Type Number:NG12003  
Description:LED has high brightness,  
low power,good sealing and long life,  
100% waterproof.  
LED quantity:6  
Voltage:12V/24V

NG12004

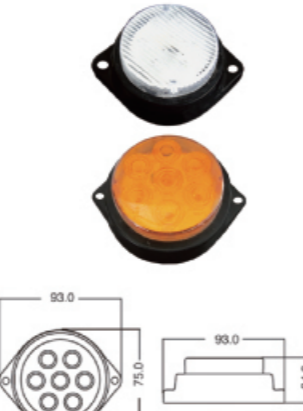

LED侧标志灯(2.5寸)

型号: NG12004  
描述: LED具有高亮度、功率低、  
密封性好、寿命长、100%防水性  
的特点。  
LED数量: 7  
电压: 12V/24V  
2.5" Side Lamp LED  
Type Number:NG12004  
Description:LED has high brightness,  
low power,good sealing and long life,  
100% waterproof.  
LED quantity:7  
Voltage:12V/24V

NG12008

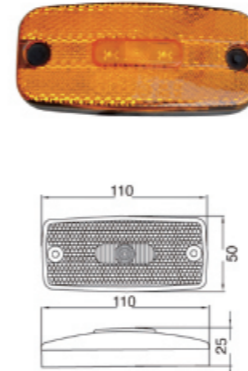

LED侧标志灯

型号: NG12008(原NG02019-1)  
描述: LED具有高亮度、功率低、  
密封性好、寿命长、100%防水性  
的特点。  
LED数量: 3  
电压: 12V/24V/9-30V  
Side Lamp LED  
Type Number:NG12008  
Description:LED has high brightness,  
low power,good sealing and long life,  
100% waterproof.  
LED quantity:3  
Voltage:12V/24V/9-30V

NG12008-1



LED侧标志灯

型号: NG12008-1  
描述: LED具有高亮度、功率低、  
密封性好、寿命长、100%防水性  
的特点。  
LED数量: 3  
电压: 12V/24V/9-30V  
Side Lamp LED  
Type Number:NG12008-1  
Description:LED has high brightness,  
low power,good sealing and long life,  
100% waterproof.  
LED quantity:3  
Voltage:12V/24V/9-30V

NG12008-2



LED侧标志灯

型号: NG12008-2  
描述: LED具有高亮度、功率低、密封性好、寿命长、100%防水性的特点。  
LED数量: 3  
电压: 12V/24V/9-30V  
Side Lamp LED  
Type Number:NG12008-2  
Description:LED has high brightness, low power,good sealing and long life, 100% waterproof.  
LED quantity:3  
Voltage:12V/24V/9-30V

NG12009



LED侧标志灯

型号: NG12009  
描述: LED具有高亮度、功率低、密封性好、寿命长、100%防水性的特点。  
LED数量: 2  
电压: 12V/24V  
Side Lamp LED  
Type Number:NG12009  
Description:LED has high brightness, low power,good sealing and long life, 100% waterproof.  
LED quantity:2  
Voltage:12V/24V/9-30V

NG12014

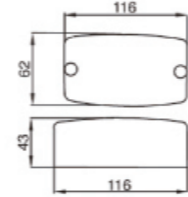

LED侧标志灯

型号: NG12014  
描述: LED具有高亮度、功率低、密封性好、寿命长、100%防水性的特点。  
电压: 12V/24V  
Side Lamp LED  
Type Number:NG12014  
Description:LED has high brightness, low power,good sealing and long life, 100% waterproof.  
Voltage:12V/24V

NG12015



LED侧标志灯

型号: NG12015  
描述: LED具有高亮度、功率低、密封性好、寿命长、100%防水性的特点。  
电压: 12V/24V  
Side Lamp LED  
Type Number:NG12015  
Description:LED has high brightness, low power,good sealing and long life, 100% waterproof.  
Voltage:12V/24V

NG12010

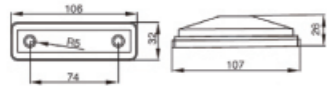

LED侧标志灯

型号: NG12010  
描述: LED具有高亮度、功率低、密封性好、寿命长、100%防水性的特点。  
电压: 12V/24V  
Side Lamp LED  
Type Number:NG12010  
Description:LED has high brightness, low power,good sealing and long life, 100% waterproof.  
Voltage:12V/24V

NG12011



LED侧标志灯

型号: NG12011  
描述: LED具有高亮度、功率低、密封性好、寿命长、100%防水性的特点。  
电压: 12V/24V  
Side Lamp LED  
Type Number:NG12011  
Description:LED has high brightness, low power,good sealing and long life, 100% waterproof.  
Voltage:12V/24V

NG12017

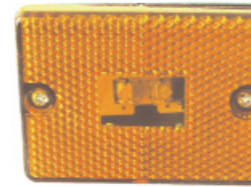

LED侧标志灯

型号: NG12017(原NG02018-2)  
描述: LED具有高亮度、功率低、密封性好、寿命长、100%防水性的特点。  
LED数量: 2  
电压: 12V/24V/9-30V  
Side Lamp LED  
Type Number:NG12017  
Description:LED has high brightness, low power,good sealing and long life, 100% waterproof.  
LED quantity:2  
Voltage:12V/24V/9-30V

NG12018



LED侧标志灯

型号: NG12018  
安装孔位: 118mm  
孔位直径: 4mm  
描述: LED具有高亮度、功率低、密封性好、寿命长、100%防水性的特点。  
LED数量: 16  
电压: 12V/24V/9-30V  
Side Lamp LED  
Type Number:NG12018  
Description:LED has high brightness, low power,good sealing and long life, 100% waterproof.  
LED quantity:16  
Voltage:12V/24V/9-30V

NG12012

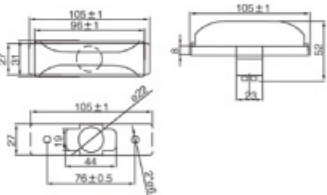

LED侧标志灯

型号: NG12012  
描述: LED具有高亮度、功率低、密封性好、寿命长、100%防水性的特点。  
电压: 12V/24V  
Side Lamp LED  
Type Number:NG12012  
Description:LED has high brightness, low power,good sealing and long life, 100% waterproof.  
Voltage:12V/24V

NG12013

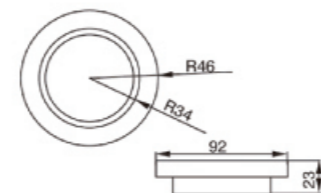

LED侧标志灯

型号: NG12013  
描述: LED具有高亮度、功率低、密封性好、寿命长、100%防水性的特点。  
电压: 12V/24V  
Side Lamp LED  
Type Number:NG12013  
Description:LED has high brightness, low power,good sealing and long life, 100% waterproof.  
Voltage:12V/24V

NG12025



LED侧标志灯

型号: NG12025  
安装孔位: 50.5mm  
孔位直径: 4mm  
描述: LED具有高亮度、功率低、密封性好、寿命长、100%防水性的特点。  
LED数量: 3  
电压: 12V/24V/9-30V  
E-MARK认证产品  
Side Lamp LED  
Type Number:NG12025  
Description:LED has high brightness, low power,good sealing and long life, 100% waterproof.  
LED quantity:3  
Voltage:12V/24V/9-30V  
E-MARK Authentication

NG16005



牌照灯

型号: NG16005  
孔位直径: 26  
License Plate Lamp  
Type Nbmber: NG16005

NG16006



牌照灯

型号: NG16006  
安装孔位: 76mm  
孔位直径: 5mm  
E-MARK认证产品  
License Plate Lamp  
Type Number: NG16006  
E-MARK Authentication

NG16007



牌照灯

型号: NG16007  
安装孔位: 45mm  
孔位直径: 4mm  
License Plate Lamp  
Type Number: NG16007

NG18005



LED工作灯

型号: NG18005(0127F)  
LED功率: 27W  
工作电压: 10-30V DC  
防水: IP68  
色温: 6000K  
材料: 铸模铝外壳  
透镜材料: 有机玻璃  
安装支架: 不锈钢  
LED Power: 27W  
Operating Voltage: 10-30V DC  
Waterproof rate: IP68  
Color temperature: 6000K  
Material: Diecast aluminum housing  
Lens material: PMMA  
Mounting bracket: Stainless Steel

NG18006



LED工作灯

型号: NG18006(0142F)  
LED功率: 42W  
工作电压: 10-30V DC  
防水: IP68  
色温: 6000K  
材料: 铸模铝外壳  
透镜材料: PC  
安装支架: 不锈钢  
LED Power: 42W  
Operating Voltage: 10-30V DC  
Waterproof rate: IP68  
Color temperature: 6000K  
Material: Diecast aluminum housing  
Lens material: PC  
Mounting bracket: Stainless Steel

NG18001



LED标杆灯

型号: NG18001  
Pole Lamp LED  
Type Number: NG18001

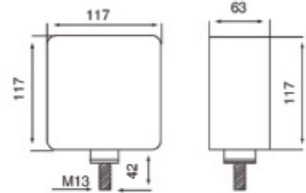

NG18002



LED标杆灯

型号: NG18002  
Pole Lamp LED  
Type Number: NG18002

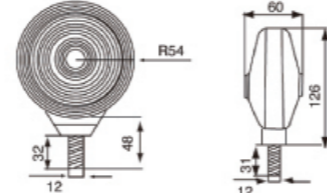

NG18007



LED工作灯

型号: NG18007(0148)  
LED功率: 48W  
工作电压: 10-60V DC  
防水: IP68  
色温: 6000K  
材料: 铸模铝外壳  
透镜材料: PC  
安装支架: 不锈钢  
LED Power: 48W  
Operating Voltage: 10-30V DC  
Waterproof rate: IP68  
Color temperature: 6000K  
Material: Diecast aluminum housing  
Lens material: PC  
Mounting bracket: Stainless Steel

NG18008



LED工作灯

型号: NG18008(0215F)  
LED功率: 15W  
工作电压: 10-30V DC  
防水: IP68  
色温: 6000K  
材料: 铸模铝外壳  
透镜材料: 有机玻璃  
安装支架: 不锈钢  
LED Power: 15W  
Operating Voltage: 10-30V DC  
Waterproof rate: IP68  
Color temperature: 6000K  
Material: Diecast aluminum housing  
Lens material: PMMA  
Mounting bracket: Stainless Steel

NG18003



LED标杆灯

型号: NG18003  
Pole Lamp LED  
Type Number: NG18003

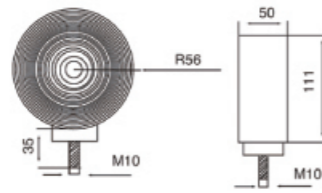

NG18004



LED工作灯

型号: NG18004(0118F)  
LED功率: 18W  
工作电压: 10-30V DC  
防水: IP68  
色温: 6000K  
材料: 铸模铝外壳  
透镜材料: 有机玻璃  
安装支架: 不锈钢  
LED Power: 18W  
Operating Voltage: 10-30V DC  
Waterproof rate: IP68  
Color temperature: 6000K  
Material: Diecast aluminum housing  
Lens material: PMMA  
Mounting bracket: Stainless Steel

NG18009



LED工作灯

型号: NG18009(0218F)  
LED功率: 18W  
工作电压: 10-30V DC  
防水: IP68  
色温: 6000K  
材料: 铸模铝外壳  
透镜材料: 有机玻璃  
安装支架: 不锈钢  
LED Power: 18W  
Operating Voltage: 10-30V DC  
Waterproof rate: IP68  
Color temperature: 6000K  
Material: Diecast aluminum housing  
Lens material: PMMA  
Mounting bracket: Stainless Steel

NG18010



LED工作灯

型号: NG18010(0310)  
LED功率: 10W  
工作电压: 10-30V DC  
防水: IP68  
色温: 6000K  
材料: 铸模铝外壳  
透镜材料: 钢化玻璃  
安装支架: 不锈钢  
LED Power: 10W  
Operating Voltage: 10-30V DC  
Waterproof rate: IP68  
Color temperature: 6000K  
Material: Diecast aluminum housing  
Lens material: Toughened glass  
Mounting bracket: Stainless Steel

NG18011



LED工作灯

型号: NG18011(0312F)  
LED功率: 12 W  
工作电压:10-30V DC  
防水: IP68  
色温: 6000K  
材料: 铸模铝外壳  
透镜材料: PC  
安装支架: 不锈钢  
LED Power: 12W  
Operating Voltage:10-30V DC  
Waterproof rate: IP68  
Color temperature:6000K  
Material: Diecast aluminum housing  
Lens material:PC  
Mounting bracket: Stainless Steel

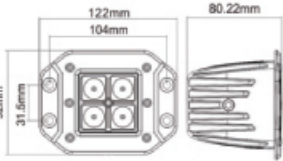

NG18012



LED工作灯

型号: NG18012(0320F)  
LED功率: 20 W  
工作电压:10-30V DC  
防水: IP68  
可选颜色: 黑色、白色  
色温: 6000K  
材料: 铸模铝外壳  
安装支架: 不锈钢  
LED Power: 20W  
Operating Voltage:10-30V DC  
Waterproof rate: IP68  
Optional Color:Brack/White  
Color temperature:6000K  
Material: Toughened glass  
Mounting bracket: Stainless Steel



NG18017



LED工作灯

型号: NG18017(0751F)  
LED功率: 51W  
工作电压:10-60V DC  
防水: IP68  
可选颜色: 黑色、红色  
色温: 6000K  
材料: 铸模铝外壳  
透镜材料: 有机玻璃  
安装支架: 不锈钢  
LED Power: 51W  
Operating Voltage:10-60V DC  
Waterproof rate: IP68  
Optional Color:Brack/Red  
Color temperature:6000K  
Material: Diecast aluminum housing  
Lens material:PMMA  
Mounting bracket: Stainless Steel

NG18018



LED工作灯

型号: NG18018(0845F)  
LED功率: 45W  
工作电压:10-30V DC  
防水: IP68  
可选颜色: 黑色、白色  
色温: 6000K  
材料: 铸模铝外壳  
透镜材料: 有机玻璃  
安装支架: 不锈钢  
LED Power: 45W  
Operating Voltage:10-30V DC  
Waterproof rate: IP68  
Optional Color:Brack/White  
Color temperature:6000K  
Material: Diecast aluminum housing  
Lens material:PMMA  
Mounting bracket: Stainless Steel

NG18013



LED工作灯

型号: NG18013(0403F)  
LED功率: 30 W  
工作电压:10-30V DC  
防水: IP68  
可选颜色: 黑色、白色  
色温: 6000K  
材料: 铸模铝外壳  
透镜材料: 有机玻璃  
安装支架: 不锈钢  
LED Power: 30W  
Operating Voltage:10-30V DC  
Waterproof rate: IP68  
Optional Color:Brack/White  
Color temperature:6000K  
Material: Diecast aluminum housing  
Lens material:PMMA  
Mounting bracket: Stainless Steel

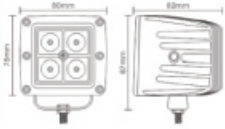

NG18014



LED工作灯

型号: NG18014(0520F)  
LED功率: 20 W  
工作电压:10-30V DC  
防水: IP68  
可选颜色: 黑色、白色  
色温: 6000K  
透镜材料: 有机玻璃  
安装支架: 不锈钢  
LED Power: 20W  
Operating Voltage:10-30V DC  
Waterproof rate: IP68  
Optional Color:Brack/White  
Color temperature:6000K  
Material: Diecast aluminum housing  
Mounting bracket: Stainless Steel

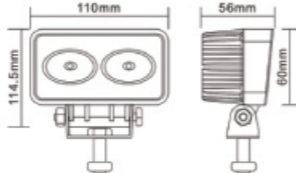

NG18019



LED工作灯

型号: NG18019(0850)  
LED功率: 10W  
工作电压:10-30V DC  
防水: IP68  
可选颜色: 黑色、白色  
色温: 6000K  
材料: 铸模铝外壳  
透镜材料: 有机玻璃  
安装支架: 不锈钢  
LED Power: 50W  
Operating Voltage:10-30V DC  
Waterproof rate: IP68  
Optional Color:Brack/White  
Color temperature:6000K  
Material: Diecast aluminum housing  
Lens material:PMMA  
Mounting bracket: Stainless Steel

NG18020



LED工作灯

型号: NG18020(9036)  
LED功率: 15 W  
工作电压:10-30V DC  
防水: IP68  
可选颜色: 黑色、白色  
色温: 6000K  
透镜材料: 有机玻璃  
安装支架: 不锈钢  
LED Power: 36W  
Operating Voltage:10-30V DC  
Waterproof rate: IP68  
Optional Color:Brack/White  
Color temperature:6000K  
Material: Diecast aluminum housing  
Lens material:PMMA  
Mounting bracket: Stainless Steel



NG18015



LED工作灯

型号: NG18015(0648F)  
LED功率: 48 W  
工作电压:10-60V DC  
防水: IP68  
可选颜色: 黑色、白色  
色温: 6000K  
材料: 铸模铝外壳  
透镜材料: PC  
安装支架: 不锈钢  
LED Power: 48W  
Operating Voltage:10-60V DC  
Waterproof rate: IP68  
Optional Color:Brack/White  
Color temperature:6000K  
Material: Diecast aluminum housing  
Mounting bracket: Stainless Steel

NG18016



LED工作灯

型号: NG18016(0690F)  
LED功率: 90W  
工作电压:10-30V DC  
防水: IP68  
色温: 6000K  
材料: 铸模铝外壳  
透镜材料: PC  
安装支架: 不锈钢  
LED Power: 90W  
Operating Voltage:10-30V DC  
Waterproof rate: IP68  
Color temperature:6000K  
Material: Diecast aluminum housing  
Lens Material:PC  
Mounting bracket: Stainless Steel

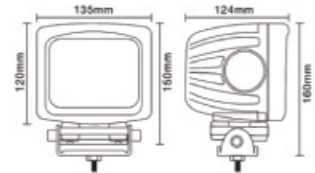

NG18021



LED侧向信号灯

型号: NG18021  
LED Lateral Signal Lamp  
Type Nmber: NG18021

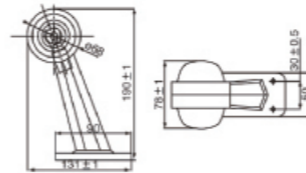

NG18022



LED侧向信号灯

型号: NG18022  
LED Lateral Signal Lamp  
Type Nmber: NG18022

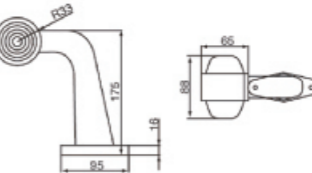

NG18031



LED报警灯

型号: NG18031  
工作电压:DC12V/24V  
颜色: 红色/黄色/蓝色/绿色  
描述: 采用72颗超高亮LED, 带爆闪, 可加抽烟器。  
安装方式: 螺丝和自吸式强力磁铁。

NG18040

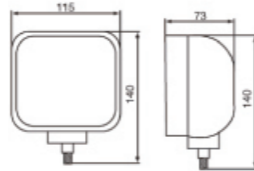

LED工作灯

型号: NG18040  
描述: LED具有亮度高、功率低、密封性好、寿命长、100%防水性的特点。  
LED数量: 24  
LED Work Lamp  
Type Number: NG18040  
Description: LED has high brightness, low power, good sealing and long life 100% waterproof.  
Voltage: 24V/12V/9-30V  
LED quantity: 24

NG18041

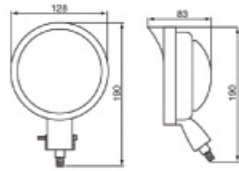

LED工作灯

型号: NG18041  
描述: LED具有亮度高、功率低、密封性好、寿命长、100%防水性的特点。  
LED数量: 24  
LED Work Lamp  
Type Number: NG18041  
Description: LED has high brightness, low power, good sealing and long life 100% waterproof.  
Voltage: 24V/12V/9-30V  
LED quantity: 24

NG18042

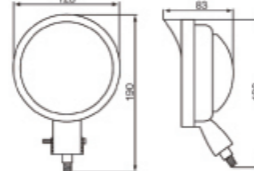

LED工作灯

型号: NG18042  
描述: LED具有亮度高、功率低、密封性好、寿命长、100%防水性的特点。  
LED数量: 24  
LED Work Lamp  
Type Number: NG18042  
Description: LED has high brightness, low power, good sealing and long life 100% waterproof.  
Voltage: 24V/12V/9-30V  
LED quantity: 24

NG18303



LED工作灯

型号: NG18303  
描述: LED具有亮度高、功率低、密封性好、寿命长、100%防水性的特点。  
LED数量: 6  
LED Work Lamp  
Type Number: NG18303  
Description: LED has high brightness, low power, good sealing and long life 100% waterproof.  
Voltage: 24V/12V/9-30V  
LED quantity: 6

NG15040



水壶(200L)

型号: NG15040  
Kettle  
Type Number: NG15040

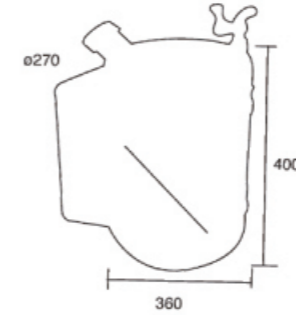

NG15041



车用水箱(450L)

型号: NG15041  
尺寸: 长x高1620x608mm  
Water Tank  
Type Number: NG15041

NG15042



车用水箱(200L)

型号: NG15042  
Water Tank  
Type Number: NG15042

NG15043



搅拌机汽路控制盒

型号: NG15043  
Type Number: NG15043

NG15044



搅拌机汽路控制盒

型号: NG15044  
Type Number: NG15044

NG15045



搅拌机汽路控制盒

型号: NG15045  
Type Number: NG15045

NG15046

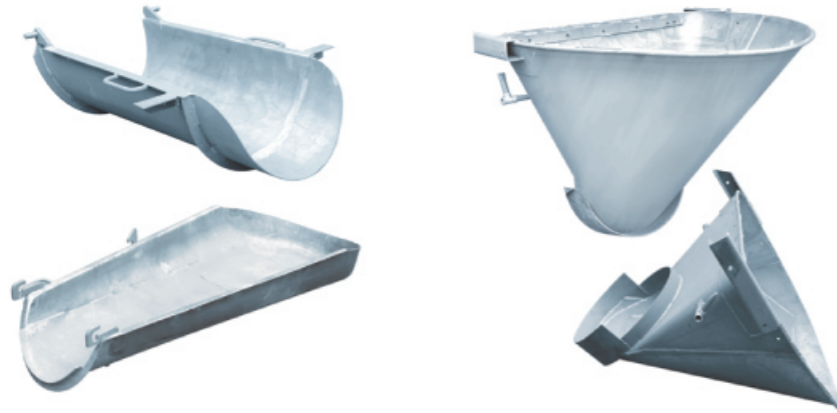

混凝土搅拌车  
进料斗三件套  
型号: NG15046  
Type Number: NG15046

NG15048



搅拌车散热器  
型号: NG15048  
Type Number: NG15048

NG15049



搅拌车侧护栏支架  
型号: NG15049  
Type Number: NG15049

NG15050



灭火器箱  
型号: NG15050  
灭火器4-8kg  
材料: 塑料  
重量: 3.7kg  
Type Number: NG15048  
Material: PP  
Weight: 3.7kg

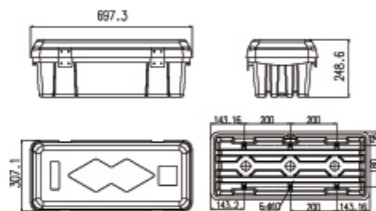

NG15051



塑料工具箱  
型号: NG15051  
适用于车辆车厢下面, 放于  
工具的箱子, 具有方便、  
轻巧、密封。

Material Tool Box  
Apply the vehicle below to  
Put in the tool box with a  
convenient, light weight an  
sealing.

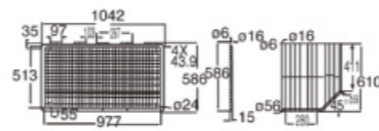

NG15051-1



塑料工具箱

型号: NG15051-1  
适用于车辆车厢下面, 放于  
工具的箱子, 具有方便、  
轻巧、密封。  
重量/Weight: 16Kg  
Material Tool Box  
Apply the vehicle below to  
Put in the tool box with a  
convenient, light weight an  
sealing.

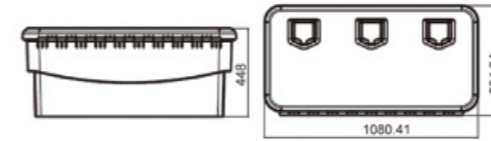

NG15052



不锈钢工具箱

型号: NG15052  
适用于车辆车厢下面, 放于  
工具的箱子, 具有方便、  
轻巧、密封。  
可根据客户要求定做

Material Tool Box  
Apply the vehicle below to  
Put in the tool box with a  
convenient, light weight an  
sealing.

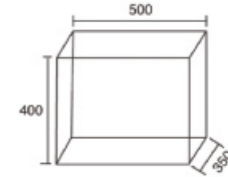

NG15053



铝合金工具箱

型号: NG15053  
适用于车辆车厢下面, 放于  
工具的箱子, 具有方便、  
轻巧、密封。  
可根据客户要求定做

Material Tool Box  
Apply the vehicle below to  
Put in the tool box with a  
convenient, light weight an  
sealing.

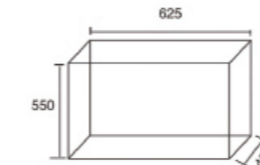

NG15054

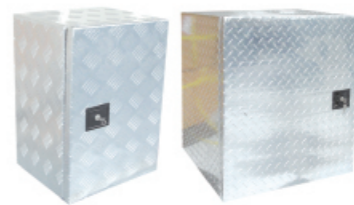

铝合金工具箱

型号: NG15054  
适用于车辆车厢下面, 放于  
工具的箱子, 具有方便、  
轻巧、密封。  
可根据客户要求定做

Material Tool Box  
Apply the vehicle below to  
Put in the tool box with a  
convenient, light weight an  
sealing.

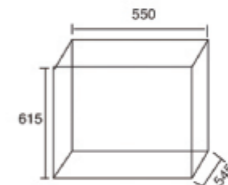

NG15055



不锈钢工具箱

型号: NG15055  
适用于车辆车厢下面, 放于  
工具的箱子, 具有方便、  
轻巧、密封。  
可根据客户要求定做

Material Tool Box  
Apply the vehicle below to  
Put in the tool box with a  
convenient, light weight an  
sealing.

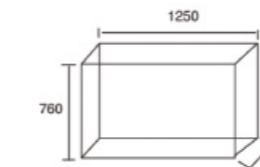

NG15056



不锈钢工具箱

型号: NG15056  
适用于车辆车厢下面, 放于  
工具的箱子, 具有方便、  
轻巧、密封。  
可根据客户要求定做

Material Tool Box  
Apply the vehicle below to  
Put in the tool box with a  
convenient, light weight an  
sealing.

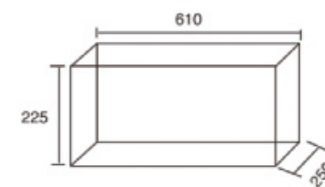

NG15057



铁工具箱

型号: NG15057  
适用于车辆车厢下面, 放于工具的箱子, 具有方便、轻巧、密封。  
可根据客户要求定做

Material Tool Box  
Apply the vehicle below to Put in the tool box with a convenient, light weight an sealing.

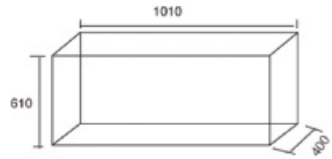

NG15058



料斗盖

型号: NG15058  
Hopper Cover

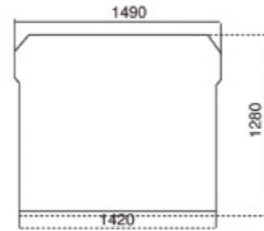

NG15063



楼梯

型号: NG15063  
Stairs  
Type Number: NG15063

NG15064

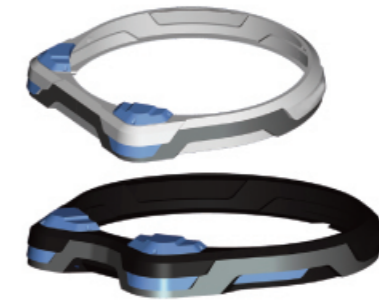

回转支撑保护圈

型号: NG15064  
Slewing Ring  
Type Number: NG15064

NG15059



主阀罩

型号: NG15059  
Main Valve Cover  
Type Number: NG15059

NG15060



工程机械楼梯踏板总成

型号: NG15060  
Engineering Machinery Staircase pedal assembly  
Type Number: NG15060

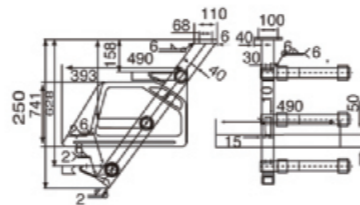

NG15065



车用电器控制盒

型号: NG15065  
Car's electrical control box  
Type Number: NG15065

NG15066



车用电器控制盒

型号: NG15066  
Car's electrical control box  
Type Number: NG15066

NG15061



料斗盖踏板

型号: NG15061  
Type Number: NG15061  
Hopper Cover Pedal

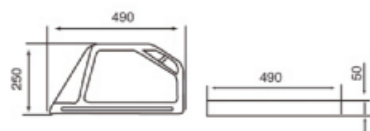

NG15062



扶手

型号: NG15062  
Type Number: NG15062  
Handrail

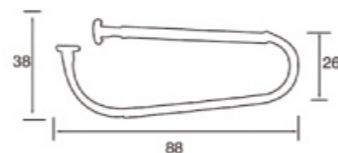

NG15067



车用电器控制盒

型号: NG15067  
Car's electrical control box  
Type Number: NG15067

NG15068



铝合金工具箱(304包边)

型号: NG15068  
适用于车辆车厢下面, 放于工具的箱子, 具有方便、轻巧、密封。  
可根据客户要求定做

Material Tool Box  
Apply the vehicle below to Put in the tool box with a convenient, light weight an sealing.

NG15069



工具箱

型号: NG15069  
适用于车辆车厢下面, 放于工具的箱子, 具有方便、轻巧、密封。  
可根据客户要求定做

Material Tool Box  
Apply the vehicle below to Put in the tool box with a convenient, light weight and sealing.

铝合金侧护栏

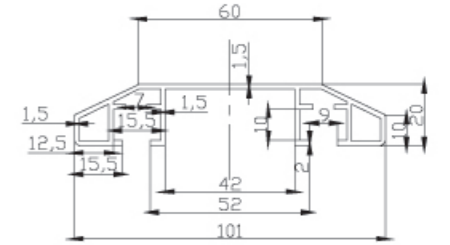

规格: 100x20mm

铝合金侧护栏

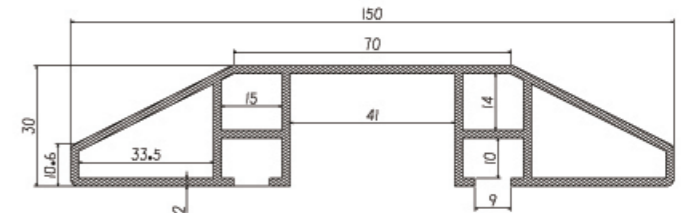

规格: 150x30mm

铝合金侧护栏

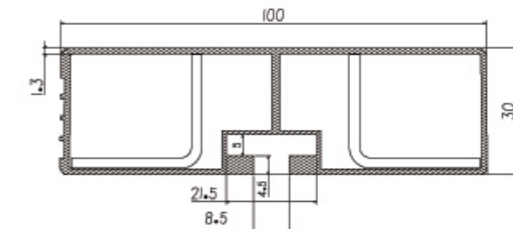

Material: Aluminum  
Weight: 1.21kg/m  
Finish: Oxide coating

材料: 铝

重量: 0.5kg/m  
表面处理: 氧化  
Material: Aluminum  
Weight: 0.5kg/m  
Finish: Oxide coating

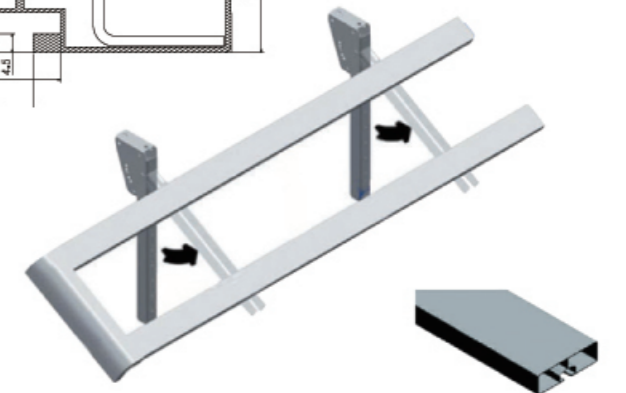
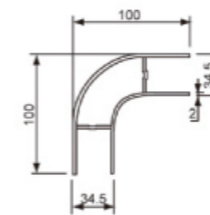

规格: 100x30mm

铝合金侧护栏保护支架

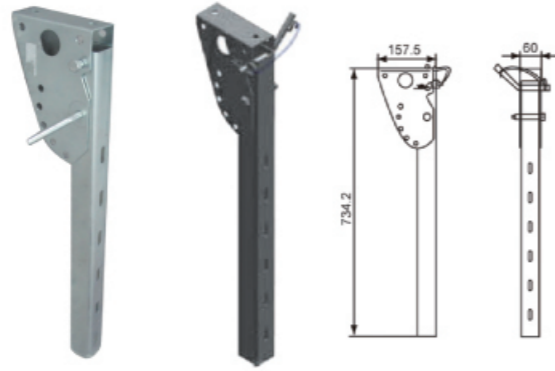

材料: 钢/不锈钢  
重量: 3.75kg/m/2.35kg/m  
表面处理: 镀锌/抛光  
Material: Steel/INOX  
Weight: 3.75kg/m/2.35kg/m  
Finish: Zinc/Polishing

备胎升降器



NG15064

铁制侧护栏



NG15070

后保险杠



紧绳器



1.35Kg

0.9Kg

1.72Kg

## 侧裙板

侧裙板可替代侧护栏适用于厢式车及专用车，尺寸可根据客户要求生产。  
The side rail can be used as a substitute for side rails and special vehicles. The size can be manufactured according to the customer's requirement.



## 厢式汽车上装厢体

为主机车厂，改装车配套服务为物流企业服务，CKD生产模式轻量化、高强度、高效率。

### 厢体特点

#### 1. 厢板结构与性能

厢板可选用整体式玻璃钢厢板，无拼接接缝，高强度，轻量化，易修补，外表面光洁平整等特点，还可选用彩钢板及整体式铝板厢板，以满足不同客户的需求！

#### 2. 厢体总体设计

上装厢体部分采用板块式拼接结构，以高强度铝合金型材包边固定，采用铆接结构，装配方便，简单易操作，根据各种厢体的结构性能，结合客户的要求，进行优化配置，最大程度的满足客户的需求！

#### 3. 上装厢体与底盘连接

厢体地板骨架与汽车底盘的大梁(半挂车和集装箱除外)连接为高强度调制的U型螺栓连接，并配以上下连接板固定，保证上装厢体的前窜，螺栓及连接板均为可拆卸连接，方便车辆的二次改装！

#### 4. 车辆附件配备

车辆除按标准配备侧护栏、后保险杠外，还可方便使用客户要求选装侧门爬梯，后门爬梯及后端液压升降围板等装置，以上设备均采用可拆卸螺栓结构，以方便以上装备的检查和维修。

### 冷藏厢式车、干货厢式车



各类专用车及工程机械液压油缸



引进先进的生产设备及工艺，定制各种液压油缸。  
Introduce advanced production equipment and process, customize various hydraulic oil cylinders.



### 汽车尾板



### 汽车液压起重尾板



### 产品型号

尾板型号	最大起重重量	电瓶电压	车厢最大离地高度	油缸内径	U型架尺寸	备注
NGWB-10/120	1吨	12V/24V	1.20米	63mm	850mm	普通型
NGWB-15/130	1.5吨	12V/24V	1.30米	80mm	950mm	普通型
NGWB-20/140	2吨	24V	1.40米	80mm	950mm	加长型

汽车尾板是安装于箱式货车和栏板车尾部的一种液压装卸机构。由机械、液压传动和电气控制组成。它以汽车上的蓄电池为动力源，可完成重达上千公斤货物的装卸。具有的快速、安全、高效的特点，大幅度节省人力、提高装卸效率，是现代物流运输的必备设备之一。广泛用于邮政、金融、石化、商业、食品、物流、制造等各行业。

### 液压装卸台产品

我公司专业为厂家设计制造各种规格、承载、高度的液压升降机、翻转式装卸台。配有护栏，装卸台举升高度最高可达2.5米以上、承载质量1吨以上。该型号的液压装卸平台，可直接安装、固定在水泥地面或基座上，通过液压叉车将货物推送到装卸平台，方便装车，大幅提高装卸效率。



