

本手册所有产品外观、颜色、参数仅供参考，最终以发出实物为准。
我们保留随时更改产品技术和说明的权利，如有变动恕不另行通知。
若有错误或不祥之处敬请谅解。
本产品技术尺寸样本的版权及解释权均属本公司所有。

All product appearance, color and parameters of this manual are for reference only, and finally the object is given.
We reserve the right to change the product technology and specifications at any time without further notice.
If there is any error or inauspicious place to be forgiven;
The copyright and interpretation rights of this product's technical dimension are all owned by the company.

专注于

专用车

半挂车

厢车

冷藏车

环卫车

工程车

南挂[®]
NANGUA

NANGUA[®]



Truck and Trailer & lamps and Parts



常州市南挂车辆部件有限公司

内销

地址：江苏省常州市新北区孟河镇工业园
电话：0519-83550298 83550710 85511931
传真：0519-83550198
Http://www.nangua-cn.com
E-mail:nangua@nangua-cn.com

CHANGZHOU NANGUA VEHICLE PARTS CO.,LTD

外贸

Add:Menghe Industrial Park Xinbei Area,Changzhou,Jiangsu
Tel: 0086-519-83550520
Fax: 0086-519-83550198
Http://www.nangua-cn.com
E-mail:nangua@nangua-cn.com

产品图册
J版



常州市南挂车辆部件有限公司
CHANGZHOU NANGUA VEHICLE PARTS CO.,LTD



国际质量体系认证



TS16949认证



CCC认证



CCC认证



E-MARK认证



扫一扫，了解更多新品

公司简介



NANGUA[®]

常州市南挂车辆部件有限公司于1992年创办成立，地处江苏省常州市新北区孟河工业开发区，临近沿江高速、沪宁高速。公司拥有优秀员工队伍。公司设有技术部、销售部、质量部、制造部、管理部、财务部、采购部等职能部门，年生产能力5000万件。

公司系科研、开发、制造、销售为一体的高新技术企业。公司拥有完整的生产及检测设备，主要生产设备有：PEI、PC等卧式注塑机、自动多工位立式注塑机、超声波塑料焊接机等先进设备。现已开发生产经营汽车灯具、挡泥罩、汽车线束及其附件产品共有三大类别，400余个品种。灯具主要品种有：后雾灯、倒车灯、LED灯、后尾灯、标志灯及示廓灯、室内顶灯。挡泥罩主要有7.00-11.00规格，涵盖了轻卡到重卡的范围。线束主要有半挂车整体线束。

公司在致力于国内OEM市场的销售，同时也开拓国外市场。国内主要配套厂家有：中集车辆（CIMC深圳、扬州通华、山东、青岛中集等）、阜阳开乐、东风商用车有限公司等。公司以顾客为关注焦点，不断增强顾客满意，严格过程控制，追求零缺陷。

公司的拖车车灯产品在2003年全部通过CCC认证，部分车灯通过美国交通运输部DOT认证。

公司奉行“诚信为本、顾客至上、以顾客盈利为目的”的经营理念，愿与国内外客商携手合作共创美好未来！

ABOUT US

Changzhou Nangua Vehicle Parts Co., Ltd is located in Menghe Industry Area, Changzhou New North District, Jiangsu, China nearby the Yanjiang and Huning highway, which was established in 1992. the company has excellent work teams. Our company has development & research, marketing, quality, manufacturing, administration, financing and purchasing Dept. meters of construction area, and the capability of 50 million units. The company is High-tech Enterprise with researching, developing, manufacturing, and marketing functions.

The company has complete production and testing equipment, the main production facilities are: the horizontal injection molding machines, automatic multi-vertical injection molding machines, ultrasonic welding plastics and other advanced equipments, such as PEI, PC and so on. We are dealing in the auto lamps, mud guards and vehicle harnesses, etc., three series products and more than 400 styles. The lighting products include Rear Fog lamps, Backup lamps, LED lamps, Tail lamps, Signal lamps, Outline Marker lamps and Room lamps. Mud guard has mainly 7.00-12.00 specifications, which is covered the light trucks to the heavy trucks scope. The harnesses are used for semi-trailer.

The company is trying to develop domestic marketing while eh- forcing the overseas marketing. The main domestic OEM customers include CIMC (Shenzhen, Yangzhou Tonghua, Shandong, and Qingdao), Fuyang Kaile, Dongfeng Commercial Vehicle Co., Ltd, and so on. The company focuses on the satisfaction of customers, continuously improve it, control process strictly and pursue zero defects.

Our products for domestic marketing all pass China Compulsory Certification (3C). Parts of auto lamps have passed function tests of seven (vibration, water, dust, corrosion, distortion, photometry and color) of American Transportation Department and pass DOT certification.

The company will regard "Credit basis, customers first and for the purpose of the customers profits", as the business policy and hope to cooperate with the clients all over the world for a glorious future.

NANGUA®

CERTIFICATION CERTIFICATE 企业资质



公司的产品全部通过权威部门的检测认证，出厂前我们也有严格检测手段，保证产品到客户的质量更加稳定可靠。

company's products all through the authoritative department certification testing, before delivery, we also have strict testing means, ensure the quality of the product to the customer is more stable and reliable.

ENTERPRISE HONOR 企业荣誉

以优质的产品赢得顾客，以良好的服务赢得市场及社会各界高度赞誉，在保证产品质量的同时，抓好企业思想建设，为社会创福利，为人民贡献是企业的最终目的。这一枚闪闪发光的铜牌，体现了政府对社会对企业的高度评价。

To win customers with high quality products, good service to win the market and the community of praise, in ensuring product quality at the same time, the enterprise ideological construction, create benefits for society, for the people's contribution is the ultimate goal of enterprises. This glittering bronze, reflects the government's social business highly.



南挂部件



MOULD DEVELOPMENT 模具开发



■ 大型数控加工中心



先进的注塑组装工艺、为产品质量打好坚实的基础，确保产品出厂合格率100%

The advanced injection molding process, and the solid foundation for the quality of the product, ensure that the product is 100%



■ 数控精雕机



■ 电火花机

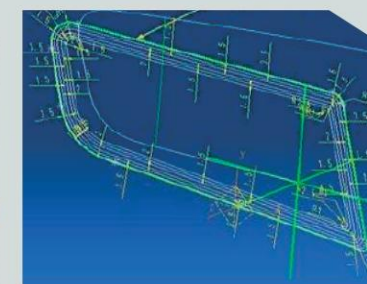

■ 数据设计中心

我们拥有精密模具零部件，采用国际先进的CAD/CAM一体化流程方案，已成为本地区规模最大，最专业的对外精密模具加工企业。力争在现有的基础上不断探索、不断创新、不断超越、以更优质、快捷的服务回报各位新老客户。

We have precision mould parts and international advanced CAD/CAM integration process, which has become the largest in the region. The most professional precision mold processing enterprise. Strive to explore constantly, innovate constantly, constantly surpass, improve the quality and speed. The service of jie is in return for your new and old customers.



目录 INDEX

车灯 (灯泡式)	01-07
反射器	08-09
挡泥罩	10-20
防飞溅系统	21-22
挡泥罩支架	23-24
挡车器	25-26
线束	27-35
车灯 (灯泡式)	36-40
LED车灯	41-72
水箱	73
工程机械部件	74
工具箱	75-77
铝合金侧护栏	78-79
全自动软篷系统	80
热塑性蜂窝板材	81-82
厢式汽车厢体	83
农业机械塑件	84-86
汽车尾板	87-88

NG01001 L/R



后组合灯 (泡式)

型号: NG01001 L/R
用途: 具有转向灯/制动灯/
后位灯的功能
灯泡型号: P21W(24V21W)、
P21/5W(24V21/5W)

3C认证产品

Tail Lamps

Type Number:NG01001 L/R

Application:With the functions of the

turn lamp,stop and rear position lamp

Bulb Mode:P21W(24V21W)、

P21/5W(24V21/5W)

3C Authentication

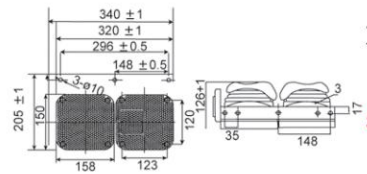

NG01002 L/R



后组合灯 (泡式)

型号: NG01002 L/R
用途: 具有制动灯/后位灯/
转向灯的功能
灯泡型号: P21W(24V21W)、
P21/5W(24V21/5W)

3C认证产品

Tail Lamps

Type Number:NG01002 L/R

Application:With the functions of the

turn lamp,stop and rear position lamp

Bulb Mode:P21W(24V21W)、

P21/5W(24V21/5W)

3C Authentication

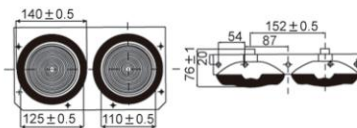

NG01007 L/R



后组合灯 (泡式)

型号: NG01007 L/R
用途: 具有转向灯/制动灯/
后位灯的功能
灯泡型号: P21W(24V21W) × 2、
P21/5W(24V21/5W)

3C认证产品

Tail Lamps

Type Number:NG01007 L/R

Application:With the functions of the

turn lamp,rear position lamp and

backup lamp

Bulb Mode:P21W(24V21W) × 2、

P21/5W(24V21/5W)

3C Authentication

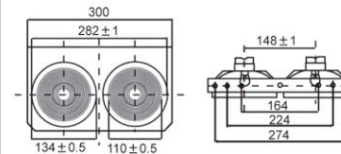

NG01008 L/R



后组合灯 (泡式)

型号: NG01008 L/R
用途: 具有制动灯/后位灯/
转向灯的功能
灯泡型号: P21W(24V21W) × 2、
P21/5W(24V21/5W)

3C认证产品

Tail Lamps

Type Number:NG01008 L/R

Application:With the functions of the

turn lamp,rear position lamp and

backup lamp

Bulb Mode:P21W(24V21W) × 2、

P21/5W(24V21/5W)

3C Authentication

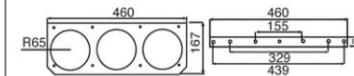

NG01003 L/R



后组合灯 (泡式)

型号: NG01003 L/R
用途: 具有转向灯/制动灯/后位灯/
倒车灯的功能
灯泡型号: P21W(24V21W) × 2、
P21/5W(24V21/5W)

3C认证产品

Tail Lamps

Type Number:NG01003 L/R

Application:With the functions of the

turn lamp,stop lamp, rear position

lamp and backup lamp

Bulb Mode:P21W(24V21W) × 2、

P21/5W(24V21/5W)

3C Authentication

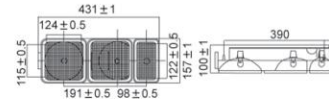

NG01004 L/R



后组合灯 (泡式)

型号: NG01004 L/R
用途: 具有转向灯/制动灯/后位灯/
倒车灯的功能
灯泡型号: P21W(24V21W) × 2、
P21/5W(24V21/5W)

3C认证产品

Tail Lamps

Type Number:NG01004 L/R

Application:With the functions of the

turn lamp,stop lamp, rear position

lamp and backup lamp

Bulb Mode:P21W(24V21W) × 2、

P21/5W(24V21/5W)

3C Authentication

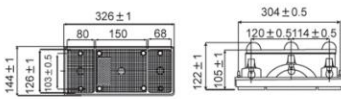

NG01005 L/R



后组合灯 (泡式)

型号: NG01005 L/R
用途: 具有转向灯/制动灯/后位灯/
倒车灯的功能
灯泡型号: P21W(24V21W)、
P21/5W(24V21/5W)

3C认证产品

Tail Lamps

Type Number:NG01005 L/R

Application:With the functions of the

turn lamp,stop lamp, rear position

lamp and backup lamp

Bulb Mode:P21W(24V21W)、

P21/5W(24V21/5W)

3C Authentication

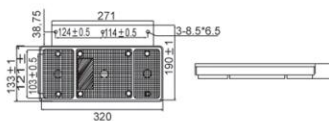

NG01006 L/R



后组合灯 (泡式)

型号: NG01006
用途: 具有转向灯/制动灯/后位灯/
倒车灯的功能
灯泡型号: P21W(24V21W) × 2、
P21/5W(24V21/5W)

3C认证产品

Tail Lamps

Type Number:NG01006

Application:With the functions of the

turn lamp,stop lamp, rear position

lamp and backup lamp

Bulb Mode:P21W(24V21W) × 2、

P21/5W(24V21/5W)

3C Authentication



NG02001



侧标志灯 (泡式)
侧标志灯支架

型号: NG02001
用途: 具有侧标志灯/转向灯/
侧回复反射器的功能

灯泡型号: R5W(24V5W)
3C认证产品
Side Lamps
Type Number:NG02001
Application:With the functions of side
marker lamp and side reflex reflector
Bulb Mode:R5W(24V5W)
3C Authentication

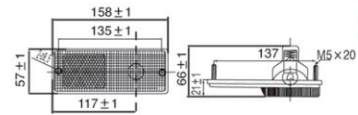

NG02002



侧标志灯 (泡式)
侧标志灯支架

型号: NG02002
用途: 具有侧标志灯/侧回复反射器
的功能

灯泡型号: W5W(24V5W)
3C认证产品
Side Lamps
Type Number:NG02002
Application:With the functions of side
marker lamp and side reflex reflector
Bulb Mode:W5W(24V5W)
3C Authentication

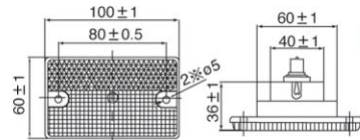

NG02003



侧标志灯 (泡式)
侧标志灯支架

型号: NG02003
用途: 具有侧标志灯/侧回复反射器
的功能

灯泡型号: W5W(24V5W)
3C认证产品
Side Lamps
Type Number:NG02003
Application:With the functions of side
marker lamp and side reflex reflector
Bulb Mode:W5W(24V5W)
3C Authentication

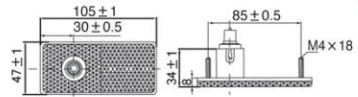

NG02004



侧标志灯 (泡式)

型号: NG02004
用途: 具有侧标志灯/侧回复反射器
的功能

灯泡型号: W5W(24V5W)
3C认证产品
Side Lamps
Type Number:NG02004
Application:With the functions of side
marker lamp and side reflex reflector
Bulb Mode:W5W(24V5W)
3C Authentication

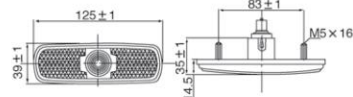

NG02005 L/R



侧标志灯 (泡式)

型号: NG02005 L/R
用途: 具有侧标志灯/侧转向/侧回复
反射器的功能

灯泡型号: P21/5W(24V5W)
Side Lamps
Type Number:NG02005 L/R
Application:With the functions of side
marker lamp and side reflex reflector
Bulb Mode:P21/5W(24V5W)

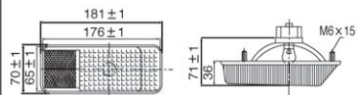

NG02006



侧标志灯 (泡式)

型号: NG02006
用途: 具有侧标志灯/侧回复反射器
的功能

灯泡型号: W5W(24V5W)
3C认证产品
Side Lamps
Type Number:NG02006
Application:With the functions of side
marker lamp and side reflex reflector
Bulb Mode:W5W(24V5W)
3C Authentication

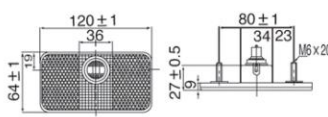

NG02007



侧标志灯 (泡式)

型号: NG02007
用途: 具有侧标志灯/侧回复反射器
的功能

灯泡型号: W5W(24V5W)
3C认证产品
Side Lamps
Type Number:NG02007
Application:With the functions of side
marker lamp and side reflex reflector
Bulb Mode:W5W(24V5W)
3C Authentication

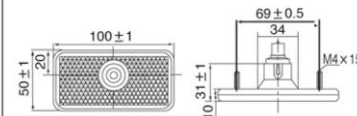

NG02008



侧标志灯 (泡式)
侧组合灯支架

型号: NG02008
用途: 具有侧标志灯/侧回复反射器/
侧转向灯的功能

灯泡型号: P21/5W(24V21/5W)
3C认证产品
Side Lamps
Type Number:NG02008
Application:With the functions of side
marker lamp and side reflex reflector
Bulb Mode:P21/5W(24V21/5W)
3C Authentication

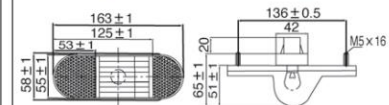

NG02009



侧标志灯 (泡式)

型号: NG02009
用途: 具有侧标志灯/侧回复反射器
的功能

灯泡型号: W5W(24V215W)
3C认证产品
Side Lamps
Type Number:NG02009
Application:With the functions of side
marker lamp and side reflex reflector
Bulb Mode:W5W(24V215W)
3C Authentication

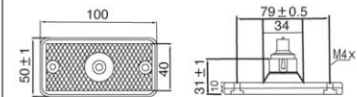

NG03002



厢式车顶灯 (泡式)

型号: NG03002
用途: 厢内照明
灯泡型号: R10W(24V10W*2)
Room Lamps
Type Number:NG03002
Application:Lighting
Bulb Mode:R10W(24V10W*2)

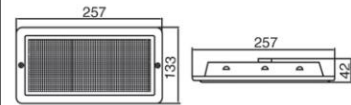

NG03003



厢式车顶灯 (泡式)

型号: NG03003
用途: 厢内照明
灯泡型号: R10W(24V10W*2)
Room Lamps
Type Number:NG03003
Application:Lighting
Bulb Mode:R10W(24V10W*2)

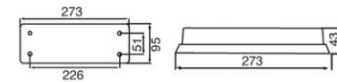

NG03004



厢式车顶灯 (泡式)

型号: NG03004
用途: 厢内照明
灯泡型号: C5W(24V5W)
Room Lamps
Type Number:NG03004
Application:Lighting
Bulb Mode:C5W(24V5W)

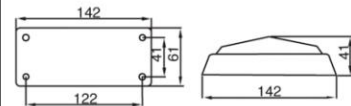

NG03005



厢式车顶灯 (不锈钢/泡式)

型号: NG03005(原NG03006)
用途: 厢内照明
灯泡型号: P21W(24V21W)
Bulb
Room Lamp(SUS)
Type Number:NG03005
Application:Lighting
Bulb Mode:P21W(24V21W)

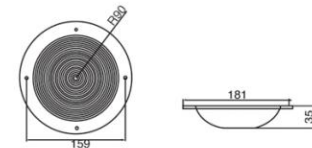

NG03006



LED不锈钢顶灯

型号: NG03006
用途: 厢内照明
电压: 12V/24V
Bulb & LED
Type Number:NG03006
Application:Lighting

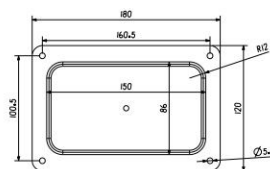

NG03007



LED厢式车顶灯 (不锈钢)

型号: NG03007
用途: 厢内照明
灯泡型号: P21W(24V21W)
Bulb&LED
Room Lamp(SUS)
Type Number:NG03007
Application:Lighting
Bulb Mode:P21W(24V21W)

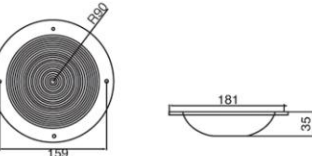

NG03008



LED车厢顶灯

型号: NG03008
性能: LED具有高亮度、功率低、密封性好、寿命长等特点
LED数量: 24
电压: 12V/24V
Room Lamp(LED)
Type Number:NG03008
Description: LED has high brightness,low power,good sealing and long life,100% waterproof
LED quantity: 24
Voltage: 12V/24V

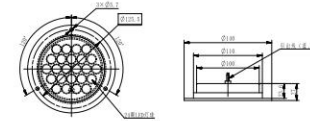

NG03009



LED车厢顶灯

型号: NG03009
性能: LED具有高亮度、功率低、密封性好、寿命长等特点
LED数量: 48
电压: 12V/24V
Room Lamp(LED)
Type Number:NG03009
Description: LED has high brightness,low power,good sealing and long life,100% waterproof
LED quantity: 48
Voltage: 12V/24V

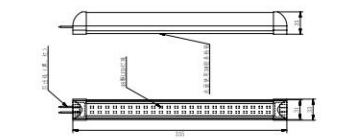

NG09210

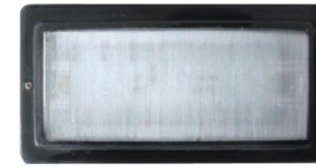

LED车厢顶灯

型号: NG09210
性能: LED具有高亮度、功率低、密封性好、寿命长等特点
LED数量: 42
电压: 12V/24V
Room Lamp(LED)
Type Number:NG09210
Description: LED has high brightness,low power,good sealing and long life,100% waterproof
LED quantity: 42
Voltage: 12V/24V

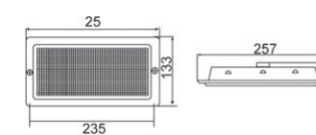

NG09211



车厢顶灯LED(可带开关)

型号: NG09211
性能: LED具有高亮度、功率低、密封性好、寿命长等特点
LED数量: 18/18
电压: 12V/24V
Room Lamp(LED)
Type Number:NG09211
Description: LED has high brightness,low power,good sealing and long life,100% waterproof
LED quantity: 18/18
Voltage: 12V/24V

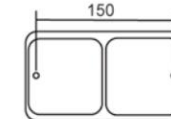

NG03010-1



危险品顶灯

规格:
B I 400x140x190
B II 500x160x220
B III 560x180x240
Hazardous Lamp
Specification:
B I 400x140x190
B II 500x160x220
B III 560x180x240

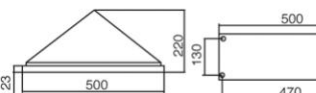

NG03010-2



① 危险品顶灯(平顶)

规格:
B I 400x140x190
B II 500x160x220
B III 560x180x240
该产品带有安装支架适用于平顶车头的安装

② 危险品顶灯(导流罩)

规格:
B I 400x140x190
B II 560x180x240
B III 500x160x220
该产品带有安装支架适用于导流罩车头的安装

NG03011

渣土车顶灯



NG04001

前回复反射器

型号: NG04001
用途: 通过外来光源照射, 反射光向位于光源附近的观察者, 表明车辆存在的位置。
3C认证产品
Front Reflex Reflector
Type Number: NG04001
Application: By external radiation light source, the reflected light to the light source in the vicinity of observer, showed that the location of vehicles
3C Authentication

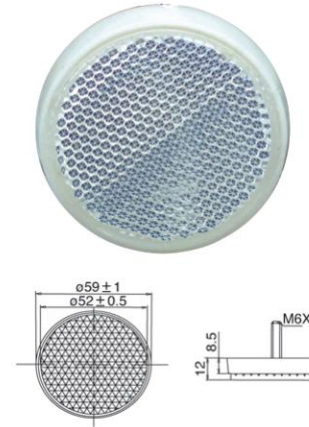

NG04002

三角后回复反射器

型号: NG04002(三孔)
用途: 通过外来光源照射, 反射光向位于光源附近的观察者, 表明车辆存在的位置。
3C认证产品
WARNING TRIANGLE
Type Number: NG04002
Application: By external radiation light source, the reflected light to the light source in the vicinity of observer, showed that the location of vehicles
3C Authentication

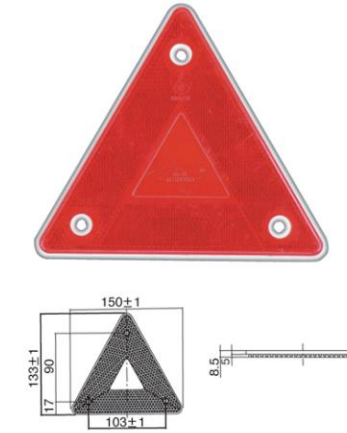

NG04003

三角后回复反射器

型号: NG04003(二孔)
用途: 通过外来光源照射, 反射光向位于光源附近的观察者, 表明车辆存在的位置。
WARNING TRIANGLE
Type Number: NG04003
Application: By external radiation light source, the reflected light to the light source in the vicinity of observer, showed that the location of vehicles

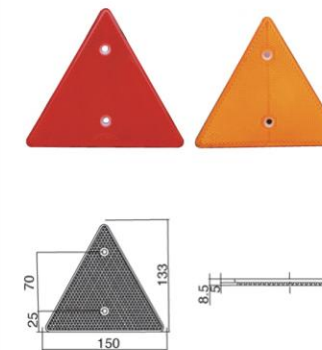

NG04005

侧回复反射器

型号: NG04005
用途: 通过外来光源照射, 反射光向位于光源附近的观察者, 表明车辆存在的位置。
3C认证产品
Side Reflex Reflector
Type Number: NG04005
Application: By external radiation light source, the reflected light to the light source in the vicinity of observer, showed that the location of vehicles
3C Authentication

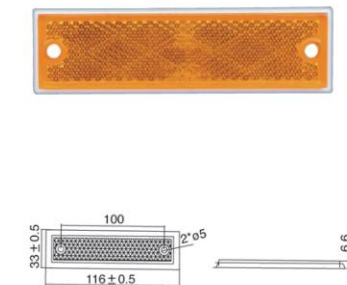

NG04007

侧回复反射器

型号: NG04007
规格: 150*25mm
用途: 通过外来光源照射, 反射光向位于光源附近的观察者, 表明车辆存在的位置。
3C认证产品
Side Reflex Reflector
Type Number: NG04011
Application: By external radiation light source, the reflected light to the light source in the vicinity of observer, showed that the location of vehicles
3C Authentication



NG04008

侧回复反射器

型号: NG04008
用途: 通过外来光源照射, 反射光向位于光源附近的观察者, 表明车辆存在的位置。
3C认证产品
Side Reflex Reflector
Type Number: NG04008
Application: By external radiation light source, the reflected light to the light source in the vicinity of observer, showed that the location of vehicles
3C Authentication

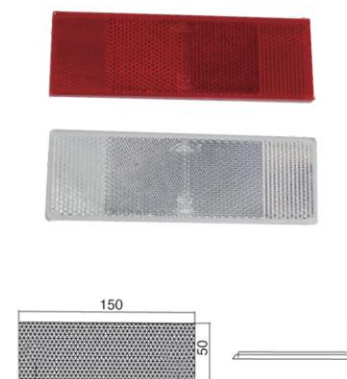

NG04009

尾部标志板

产品规格:565*200±10(mm)
1130*200±10(mm)

产品说明:红色边框宽度为40mm
红色荧光膜边框,黄色为反光材料
适用车型:长型、重型车辆(如挂车
或半挂车)

3C认证产品
具备检测报告

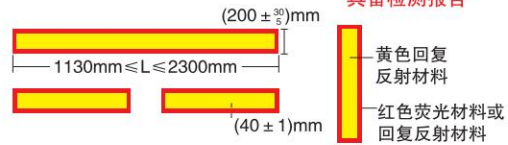

NG04010

尾部标志板

产品规格:565*140±10(mm)
1130*140±10(mm)

条纹规格:142*100mm
产品说明:斜向条纹45° 红色均为
反光材料

适用车型:长型、重型车辆
3C认证产品
具备检测报告

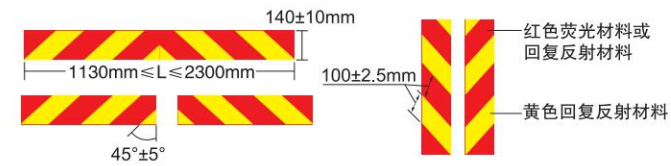

NG05001

轮胎挡泥罩

型号: NG05001
尺寸: 跨度×宽度×高度
1300±20×640±10×675±5
弧长/Arc Length: 2100±15
Tire Mud Guard
Type Number:NG05001
Measurement:
Span×Width×Height
1300±20×640±10×675±5

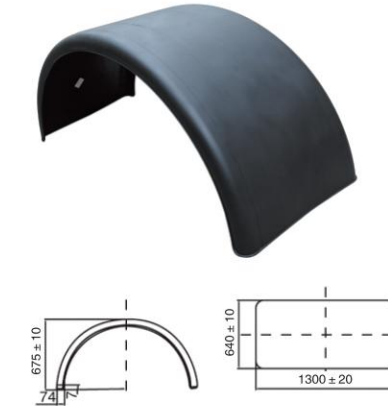

挡泥罩组件

- 轮胎挡泥罩组件
1.轮胎挡泥罩
2.挡泥罩调节压板
3.挡泥罩支架直管
4.挡泥皮
5.挡泥罩支架弯管

Tire Mud Guare Assembly
1.Tire Mud Guard
2.Adjusting Clamp
3.Mud Guard Bracket
4.Mud Guard Flat
5.Stent Band Tube

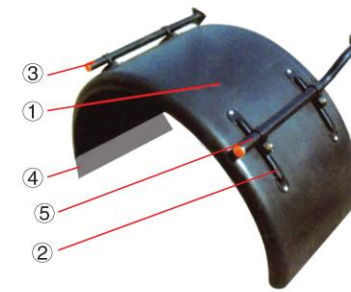

NG05002

轮胎挡泥罩

型号: NG05002
尺寸: 跨度×宽度×高度
1300±20×630±10×580±10
弧长/Arc Length: 1935±15
Tire Mud Guard
Type Number:NG05002
Measurement:
Span×Width×Height
1300±20×630±10×580±10

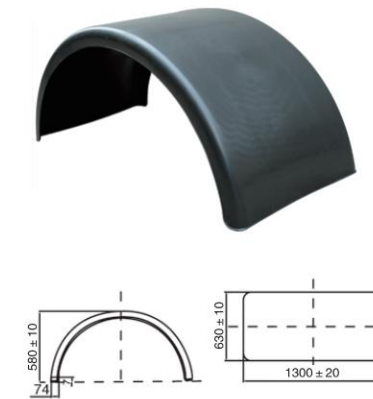

NG05003

分体式挡泥罩

型号: NG05003
尺寸: 长度×宽度
635±5×650±10
管夹: Φ38 Φ42
弧长/Arc Length: 700±10
Detachable Tire Mud Guard
Type Number:NG05003
Measurement:
Length×Width
635±5×650±10

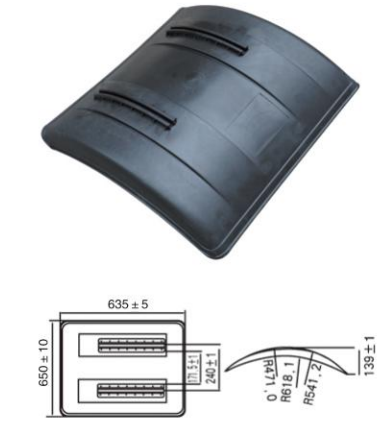

NG05004

分体式挡泥罩

型号: NG05004
尺寸: 长度×宽度
650±5×510±10
管夹: Φ38 Φ42
弧长/Arc Length: 700±10
Detachable Tire Mud Guard
Type Number:NG05004
Measurement:
Length×Width
650±5×510±10



NG05005

轮胎挡泥罩

型号: NG05005
尺寸: 长度×宽度×高度
960±20×460±10×480±10
弧长/Arc Length: 1510±15
Tire Mud Guard
Type Number:NG05005
Measurement:
Span×Width×Height
960±20×460±10×480±10



NG05006



轮胎挡泥罩
型号: NG05006
尺寸: 跨度×宽度×高度
1270±20×500±10×610±10
弧长/Arc Length: 1950±15
Tire Mud Guard
Type Number:NG05006
Measurement:
Span×Width×Height
1270±20×500±10×610±10

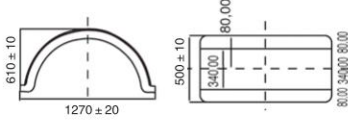

NG05006-1



轮胎挡泥罩
型号: NG05006-1
尺寸: 长度×宽度×高度
1200±20×480±10×575±10
弧长/Arc Length: 1840±15
Tire Mud Guard
Type Number:NG05006-1
Measurement:
Span×Width×Height
1200±20×480±10×575±10

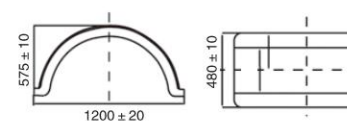

NG05007



轮胎挡泥罩(加强型)
型号: NG05007
尺寸: 跨度×宽度×高度
1270±20×630±10×595±10
弧长/Arc Length: 1910±15
功能: 挡泥罩采用凹凸加强设计, 具有硬度强, 美观防止雨水飞溅, 导流作用。
Tire Mud Guard (Stredhthen)
Type Number:NG05007
Measurement:
Span×Width×Height
1270±20×630±10×595±10
Mud guard is adopted to use the strength concaveconvex design wht the strong hardness,aestheic preventing from splashing water, and diversion effects

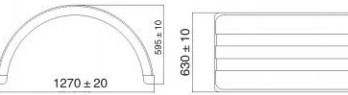

NG05007-1



轮胎挡泥罩(加强型)
型号: NG05007-1
尺寸: 跨度×宽度×高度
1270±20×675±10×600±10
弧长/Arc Length: 1910±15
功能: 挡泥罩采用凹凸加强设计, 具有硬度强, 美观防止雨水飞溅, 导流作用(滑槽/白边颜色可任选)
Tire Mud Guard (Stredhthen)
Type Number:NG05007-1
Measurement:
Span×Width×Height
1270±20×675±10×600±10
Mud guard is adopted to use the strength concaveconvex design wht the strong hardness,aestheic preventing from splashing water, and diversion effects

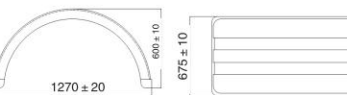

NG05008



轮胎挡泥罩(加强型)
型号: NG05008
尺寸: 跨度×宽度×高度
1300±20×660±10×680±10
弧长/Arc Length: 2090±15
功能: 挡泥罩采用凹凸加强设计, 具有硬度强, 美观防止雨水飞溅, 导流作用。
Tire Mud Guard
Type Number:NG05008
Measurement:
Span×Width×Height
1300±20×660±10×680±10
Mud guard is adopted to use the strength concaveconvex design wht the strong hardness,aestheic preventing from splashing water, and diversion effects

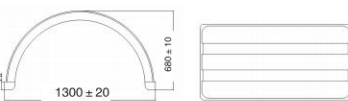

NG05008-1

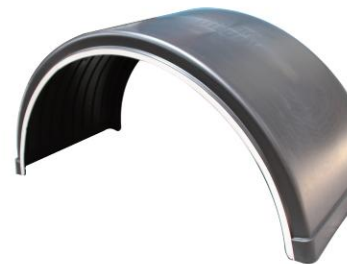

轮胎挡泥罩
型号: NG05008-1
尺寸: 跨度×宽度×高度
1300±20×650±10×685±10
弧长/Arc Length: 2090±15
Tire Mud Guard
Type Number:NG05008
Measurement:
Span×Width×Height
1300±20×650±10×685±10

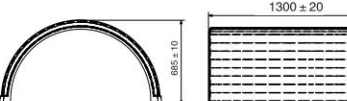

NG05009



挡泥罩
型号: NG05009
尺寸: 跨度×宽度×高度
1270±20×630±10×610±10
弧长/Arc Length: 1920±15
Tire Mud Guard
Type Number:NG05009
Measurement:
Span×Width×Height
1270±20×630±10×610±10

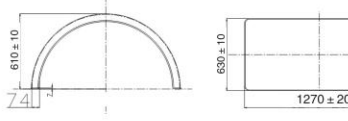

NG05015



双轴轮胎挡泥罩(不锈钢)
型号: NG05015
尺寸: 长度×宽度×高度
2660×620×600
弧长/Arc Length: 3330
Tire Mud Guard
Type Number:NG05015
Measurement:
Span×Width×Height
2660×620×600
备注: 跨度和高度可根据客户需求定制

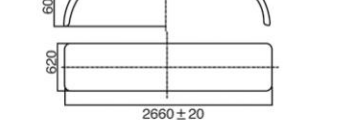

NG05016

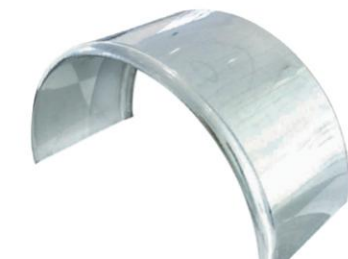

轮胎挡泥罩(不锈钢)
型号: NG05016
尺寸: 跨度×宽度×高度
1270×620×630
弧长/Arc Length: 1950
Tire Mud Guard
Type Number:NG05016
Measurement:
Span×Width×Height
1270×620×630

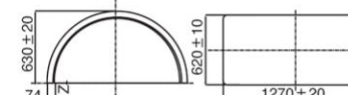

NG05017

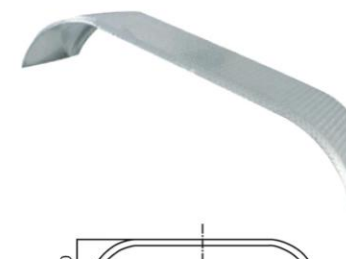

双轴轮胎挡泥罩(铝合金)
型号: NG05017
尺寸: 跨度×宽度×高度
2660×620×600
弧长/Arc Length: 3330
Tire Mud Guard
Type Number:NG05017
Measurement:
Span×Width×Height
2660×620×600
备注: 跨度和高度可根据客户需求定制

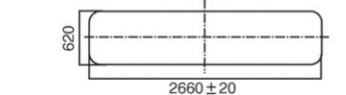

NG05018



轮胎挡泥罩(铝合金)
型号: NG05018
尺寸: 跨度×宽度×高度
1270×620×630
弧长/Arc Length: 1950
Tire Mud Guard
Type Number:NG05018
Measurement:
Span×Width×Height
1270×620×630



NG05019



分体式挡泥罩(铝合金)
型号: NG05019
尺寸: 跨度×宽度×高度
680×620×110
弧长/Arc Length: 660
Split Mud Guard
Type Number:NG05019
Measurement:
Span×Width×Height
680×620×110



NG05026



挡泥罩

型号: NG05026
尺寸: 长度 × 宽度 × 高度
660 ± 20 × 210 ± 10 × 325 ± 10
弧长/Arc Length: 1055 ± 15
Tire Mud Guard
Type Number: NG05026
Measurement:
Span × Width × Height
660 ± 20 × 210 ± 10 × 325 ± 10

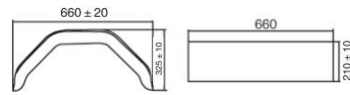

NG05027



挡泥罩

型号: NG05027
尺寸: 长度 × 宽度 × 高度
770 ± 20 × 215 ± 10 × 325 ± 10
弧长/Arc Length: 1130 ± 15
Tire Mud Guard
Type Number: NG05027
Measurement:
Span × Width × Height
770 ± 20 × 215 ± 10 × 325 ± 10

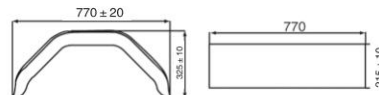

NG05028



挡泥罩

型号: NG05028
尺寸: 跨度 × 宽度 × 高度
1660 ± 20 × 23 ± 10 × 360 ± 10
弧长/Arc Length: 2020 ± 15
Tire Mud Guard
Type Number: NG05028
Measurement:
Span × Width × Height
1660 ± 20 × 23 ± 10 × 360 ± 10

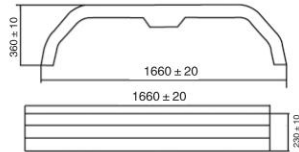

NG05029



挡泥罩

型号: NG05029
尺寸: 跨度 × 宽度 × 高度
590 × 180 × 160
弧长/Arc Length: 660
Tire Mud Guard
Type Number: NG05029
Measurement:
Span × Width × Height
590 × 180 × 160

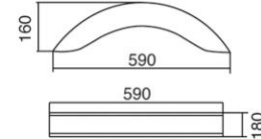

NG05069



分体式挡泥罩(铝合金)

型号: NG05069
尺寸: 跨度 × 宽度 × 高度
950 × 620 × 220
弧长/Arc Length: 1060
Split Mud Guard
Type Number: NG05069
Measurement:
Span × Width × Height
950 × 620 × 220
备注: 跨度和高度可根据
客户需求定制

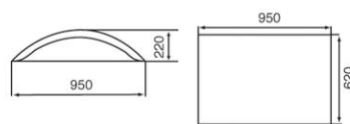

NG05070

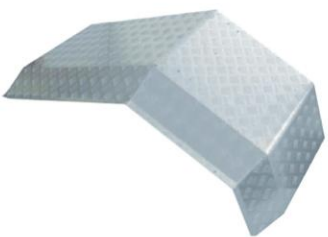

整体式挡泥罩(铝合金)

型号: NG05070
弧长/Arc Length: 1850
Split Mud Guard
Type Number: NG05070
备注: 跨度和高度可根据
客户需求定制

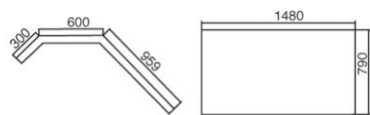

NG05071

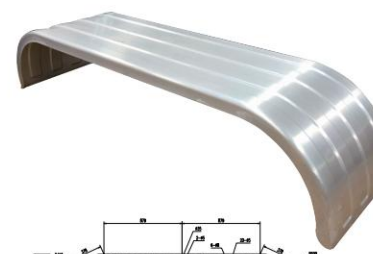

双轴轮胎挡泥罩(铝合金)

型号: NG05071
尺寸: 跨度 × 宽度 × 高度
2712 × 650 × 555
弧长/Arc Length: 3330
Tire Mud Guard
Type Number: NG05071
Span × Width × Height
2712 × 650 × 555

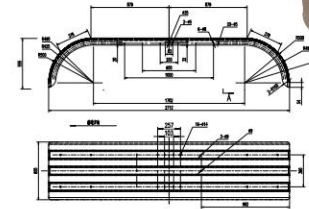

NG05071-1

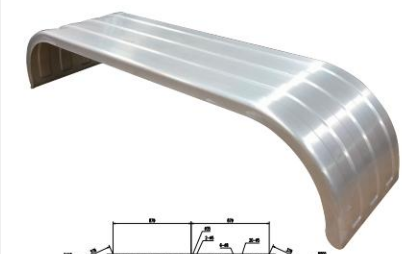

双轴轮胎挡泥罩(铁)

型号: NG05071-1
尺寸: 跨度 × 宽度 × 高度
2712 × 650 × 555
弧长/Arc Length: 3330
Tire Mud Guard
Type Number: NG05071-1
Span × Width × Height
2712 × 650 × 555

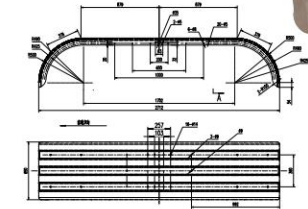

NG05074



轮胎挡泥罩(铁/加强型)

型号: NG05074
尺寸: 跨度 × 宽度 × 高度
1250 × 485 × 600
1250 × 620 × 600
1250 × 670 × 600
弧长/Arc Length: 1950
Type Number: NG05074
Mud guard is adopted to use the
strengthened concaveconvex design,
with the strong
hardness, aesthetic, preventing
from splashing water and
diversion effects
备注: 跨度和高度可根据
客户需求定制

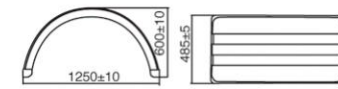

NG05075



双轴轮胎挡泥罩(铁/加强型)

型号: NG05075
尺寸: 跨度 × 宽度 × 高度
2660 × 485 × 600
2660 × 620 × 600
2660 × 670 × 600
弧长/Arc Length: 3400
Type Number: NG05075
备注: 跨度和高度可根据
客户需求定制

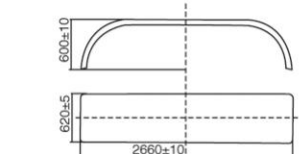

NG05076



三轴轮胎挡泥罩(铁/加强型)

型号: NG05076
尺寸: 跨度 × 宽度 × 高度
4010 × 485 × 600
4010 × 620 × 600
4010 × 670 × 600
弧长/Arc Length: 4700
Tire Mud Guard
Type Number: NG05076
备注: 跨度和高度可根据
客户需求定制

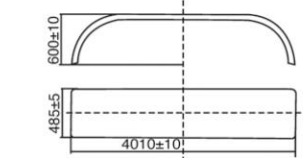

NG05077



轮胎挡泥罩(铁)

型号: NG05077
尺寸: 长度 × 宽度 × 高度
1250 × 485 × 600
1250 × 660 × 600
弧长/Arc Length: 1950
Tire Mud Guard
Type Number: NG05077

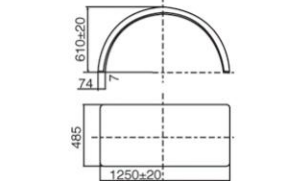

NG05078



双轴轮胎挡泥罩(铁/加强型)

型号: NG05078
尺寸: 跨度×宽度×高度
2660×485×600
2660×660×600
弧长/Arc Length: 3330
Tire Mud Guard
Type Number:NG05078

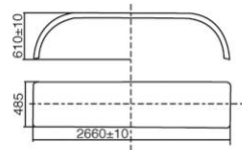

NG05079



三轴轮胎挡泥罩(铁/加强型)

型号: NG05079
尺寸: 跨度×宽度×高度
4010×485×600
4010×660×600
弧长/Arc Length: 4700
Tire Mud Guard
Type Number:NG05079

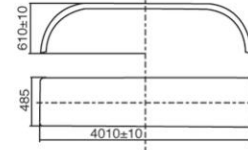

NG05080



轮胎挡泥罩(铝合金/加强型)

型号: NG05080
尺寸: 跨度×宽度×高度
1250×485×600
1250×620×600
1250×670×600
弧长/Arc Length: 1950
功能: 挡泥罩采用凹凸加强设计, 具有硬度强, 美观防止雨水飞溅, 导流作用。
Tire Mud Guard(Stredgthen)
Type Number:NG05080
Mud guard is adopted to use the strengthe concaveconvex design, with the strong hardness,aesthetic, preventing from splashing water and diversion effects
备注: 跨度和高度可根据客户需求定制



NG05081



双轴轮胎挡泥罩(铝合金/加强型)

型号: NG05081
尺寸: 跨度×宽度×高度
2660×485×600
2660×620×600
2660×670×600
弧长/Arc Length: 3400
Tire Mud Guard
Type Number:NG05081
备注: 跨度和高度可根据客户需求定制

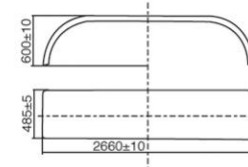

NG05082



三轴轴挡泥罩(铝合金/加强型)

型号: NG05082
尺寸: 长度×宽度×高度
4010×485×600
4010×620×600
4010×670×600
弧长/Arc Length: 4700
Tire Mud Guard
Split Mud Guard
Type Number:NG05082
备注: 跨度和高度可根据客户需求定制

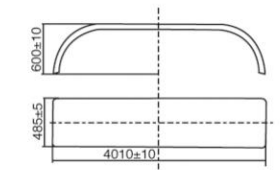

NG05083



轮胎挡泥罩

型号: NG05083
尺寸: 长度×宽度×高度
935±5×240±10×300±10
弧长/Arc Length: 1270±15
Split Mud Guard
Type Number:NG05083
Measurement:
Span×Width×Height
935±5×240±10×300±10

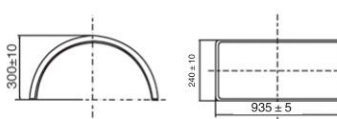

NG05084



轮胎挡泥罩

型号: NG05084
尺寸: 跨度×宽度×高度
780×220×385
弧长/Arc Length: 1150
Split Mud Guard
Type Number:NG05084
Measurement:
Span×Width×Height
780×220×385

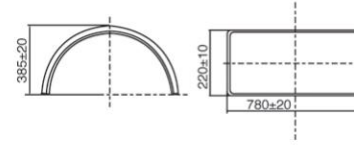

NG05101



轮胎挡泥罩

型号: NG05101
尺寸: 跨度×宽度×高度
1270±20×680±10×680±10
弧长/Arc Length: 2040±15
Split Mud Guard
Type Number:NG05101
Measurement:
Span×Width×Height
1270±20×680±10×680±10
Apply to the specification of 1200\1100 and 1000 tires

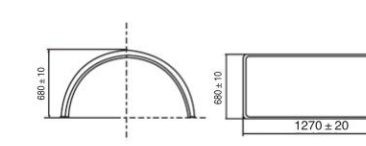

NG05102



轮胎挡泥罩

型号: NG05102
尺寸: 长度×宽度×高度
1270±20×460±10×670±5
弧长/Arc Length: 2020±15
Split Mud Guard
Type Number:NG05102
Measurement:
Span×Width×Height
1270±20×460±10×670±5

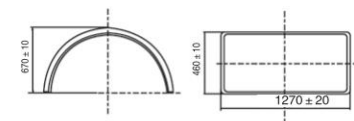

NG05103



轮胎挡泥罩

型号: NG05103
尺寸: 长度×宽度×高度
1300×630×620
弧长/Arc Length: 2000
Tire Mud Guard
Type Number:NG05103
Measurement:
Span×Width×Height
1300×630×620

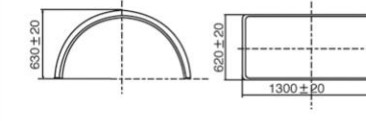

NG05104



轮胎挡泥罩

型号: NG05104
尺寸: 长度×宽度×高度
1500×640×700
弧长/Arc Length: 2100
Tire Mud Guard
Type Number:NG05104
Measurement:
Span×Width×Height
1500×640×700

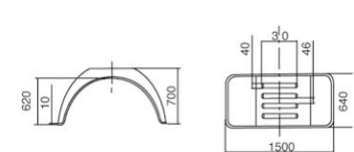

NG05105



轮胎挡泥罩(铝合金/加强型)

型号: NG05105
尺寸: 长度×宽度×高度
1250×485×600
1250×660×600
Tire Mud Guard(Stredgthen)
Type Number:NG05105
Mud guard is adopted to use the strengthe concaveconvex design with the strong hardness,aesthetic,preventing from splashing water and diversion effects

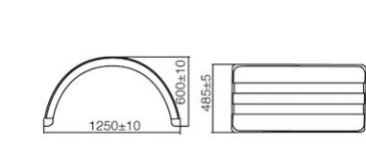

NG05106

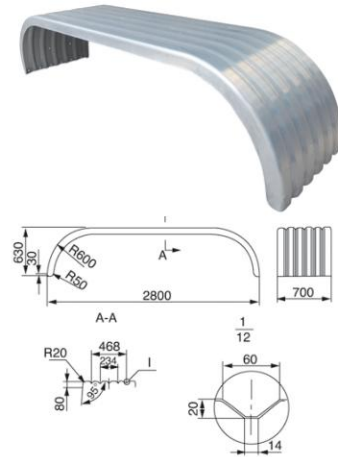

轮胎挡泥罩(铝合金)

型号: NG05106
尺寸: 跨度×宽度×高度
2800×700×630
弧长/Arc Length: 2020
Split Mud Guard
Type Number: NG05106
Measurement:
Span×Width×Height
2800×700×630

NG05109



轮胎挡泥罩

型号: NG05109
尺寸: 长度×宽度×高度
1050±20×535±10×500±10
弧长/Arc Length: 1580±15
Tire Mud Guard
Type Number: NG05109
Measurement:
Span×Width×Height
1050±20×535±10×500±10

NG05110



轮胎挡泥罩

型号: NG05110
尺寸: 长度×宽度×高度
960×480×480
弧长/Arc Length:
Tire Mud Guard
Type Number: NG05110
Measurement:
Span×Width×Height
960×480×480

NG05111



轮胎挡泥罩

型号: NG05111
尺寸: 长度×宽度×高度
1270±20×660±10×610±10
弧长/Arc Length: 1915±15
Tire Mud Guard
Type Number: NG05111
Measurement:
Span×Width×Height
1270±20×660±10×610±10

NG05112



轮胎挡泥罩

型号: NG05112
尺寸: 长度×宽度×高度
1280±20×520±10×620±10
弧长/Arc Length:
Tire Mud Guard
Type Number: NG05112
Measurement:
Span×Width×Height
1280±20×520±10×620±10

NG05113



轮胎挡泥罩

型号: NG05113
尺寸: 长度×宽度×高度
765×420×320
弧长/Arc Length:
Tire Mud Guard
Type Number: NG05113
Measurement:
Span×Width×Height
765×420×320

NG05114

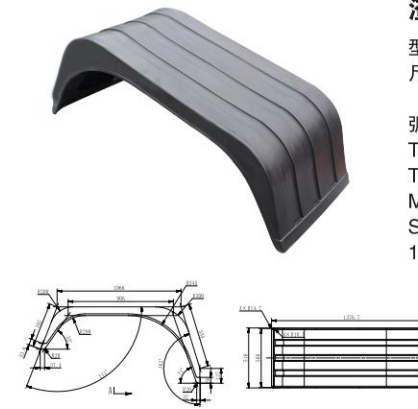

渣土车专用挡泥罩(前)

型号: NG05114
尺寸: 长度×宽度
1376×516
弧长/Arc Length:
Tire Mud Guard
Type Number: NG05114
Measurement:
Span×Width
1376×516

NG05115

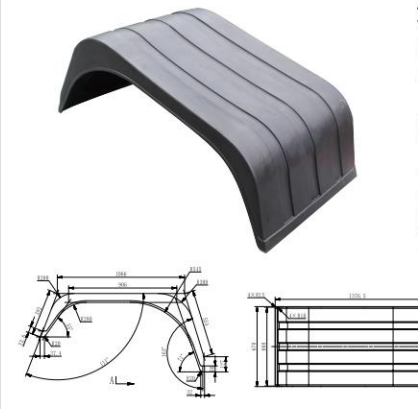

渣土车专用挡泥罩(后)

型号: NG05115
尺寸: 长度×宽度
1376×670
弧长/Arc Length:
Tire Mud Guard
Type Number: NG05115
Measurement:
Span×Width
1376×670

NG05020



轮胎挡泥皮

型号: NG05020
描述: 采用PVC板材加工,
可采用PE材料, 耐高温、低温。
Tire Mud Flat
Type Number: NG05020
Description: Using the PVC
sheet processing

NG05021

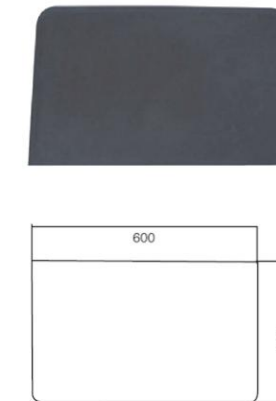

轮胎挡泥皮

型号: NG05021
描述: 采用橡胶材质模具一次性
注塑而成
Tire Mud Flat
Type Number: NG05021
Description: Using a rubber
material mold from injection

NG05022



轮胎挡泥皮

型号: NG05022
描述: 采用橡胶材质模具一次性
注塑而成
Tire Mud Flat
Type Number: NG05022
Description: Using a rubber
material mold from injection

NG05107 双轴双胎挡泥罩 (塑料/分体组合)

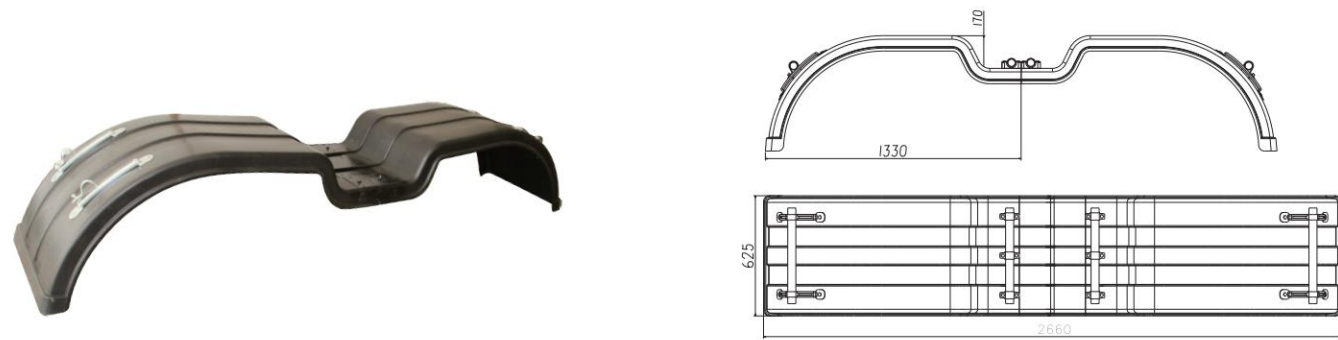

NG05108 三轴双胎挡泥罩 (塑料/分体组合)

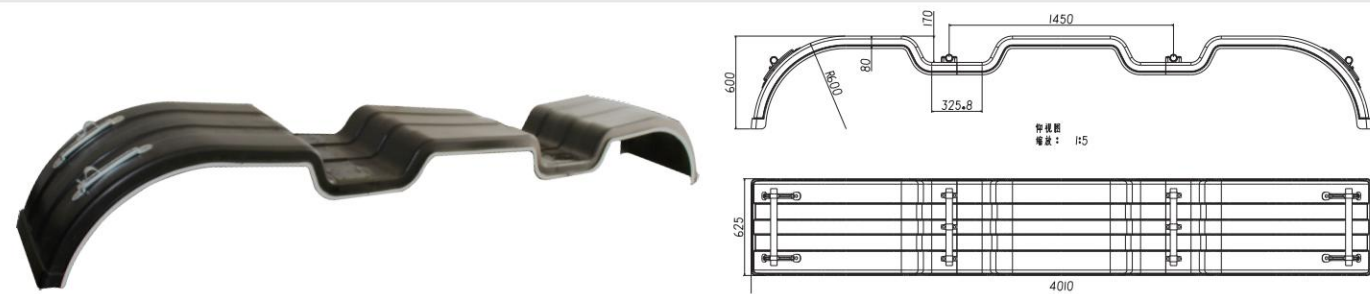

NG05107-1 双轴双胎挡泥罩 (铁)



NG05108-1 三轴双胎挡泥罩 (铁)

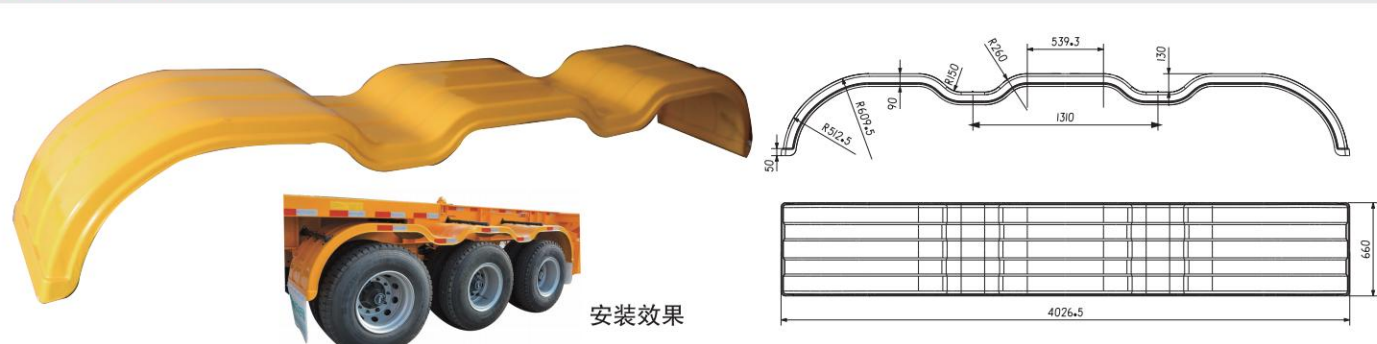

NG05108-2 三轴双胎挡泥罩 (塑料/轻量化/免喷漆)

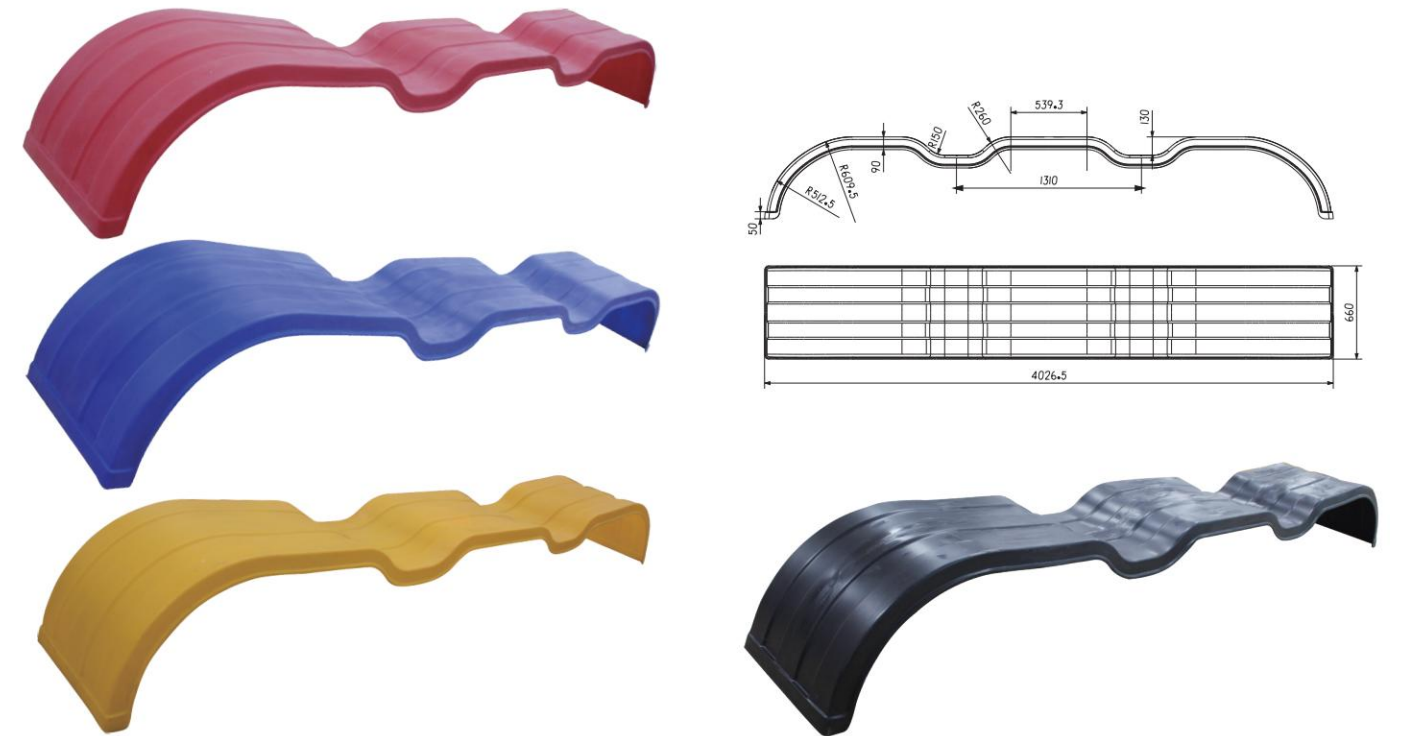

NG05116 双轴双胎挡泥罩 (塑料)

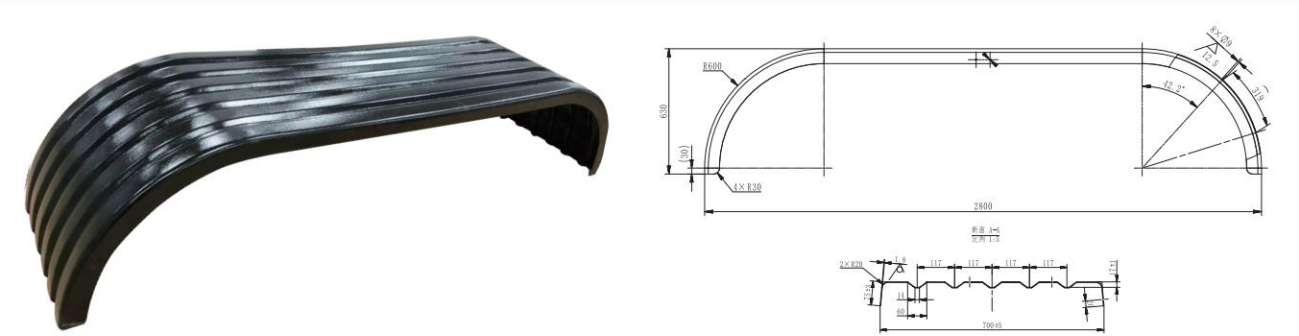

防飞溅系统

我公司针对国家《GB7258》规定，卡车和挂车防飞溅系统要求，开发了多款适用各种卡车及挂车防飞溅系统，均符合《GB34659-2017》国家标准。



NG05024



NG05024



双桥/三桥防飞溅系统示意图

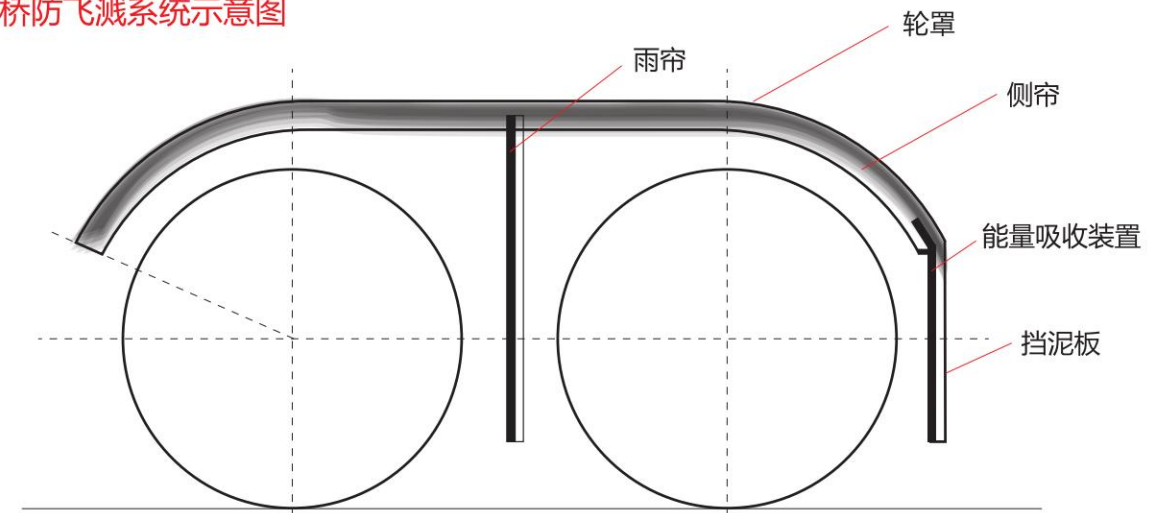

单桥防飞溅系统示意图

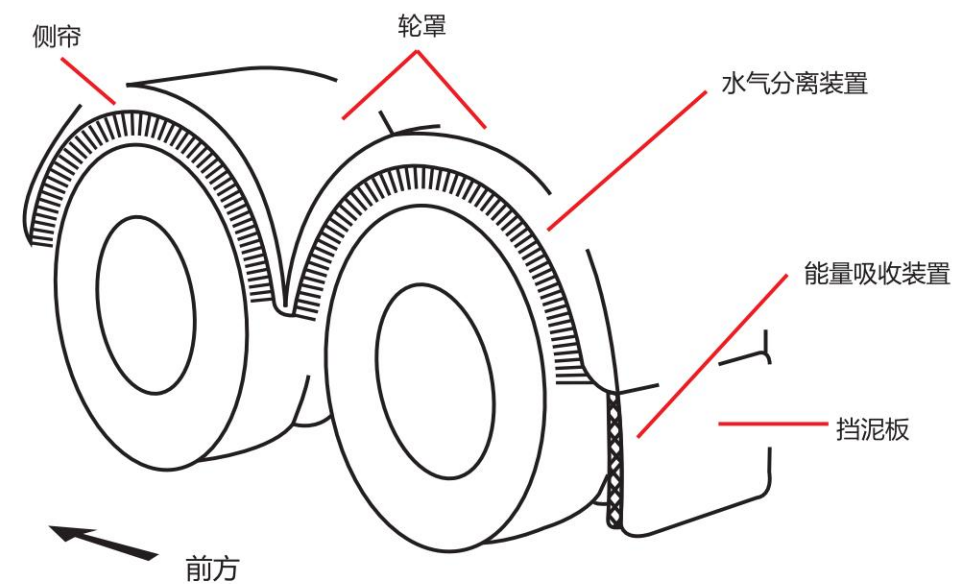

NG05023



NG05023



NG05023

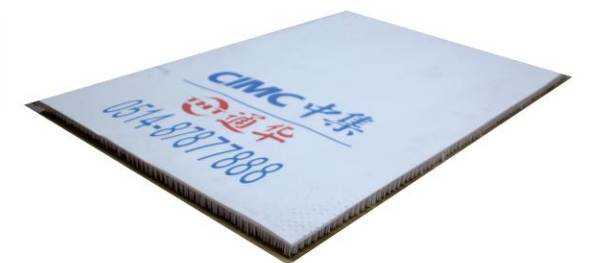

NG05023

NG05010



挡泥罩支架(直管)

型号: NG05010(锌Φ42/38)
NG05010(黑Φ42/38)
用途: 连接挡泥罩和压板
Bracket(Strent Tube)Iron
Type Number:
NG05010(galvanizing)
NG05010(painting)
Application:Connecting to the
mud guard and clamp

NG05011



挡泥罩支架(弯管/铁)

型号: NG05011(锌Φ42/38)
NG05011(黑Φ42/38)
用途: 连接挡泥罩和压板,
可调节角度。
Bracket(Strent Tube)Iron
Type Number:
NG05011(galvanizing)
NG05011(painting)
Application:Connecting to the
mud guard and clamp it can
adjust the angles

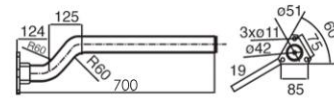

NG05015-1



挡泥罩支架(铝合金)

型号: NG05015-1
用途: 连接挡泥罩和压板。
Bracket(Strent Tube)Iron
Type Number:
Application:Connecting to the
mud guard and clamp it can
adjust the angles

NG045010



挡泥罩调节压板

材料: 钢
重量: 0.58kg
表面处理: 镀锌
Material:steel
Weight:0.58kg
Finish:zinc

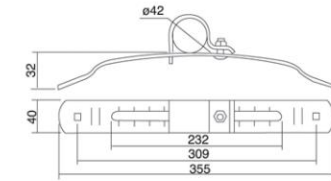

NG05012



挡泥罩上下压板(铁)

型号: NG05012(黑)
适用于支架与挡泥罩之间的连接
UL Clamp(Iron)
Type Bumper:
NG05012(painting)
Using to connect between
bracketand mud guard

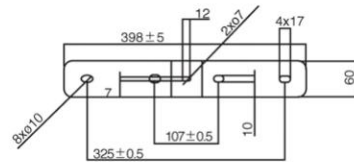

NG05013



挡泥罩调节压板(铁)

型号: NG05013(镀锌)
NG05013(喷漆)
适用于支架与挡泥罩之间的连接
可以根据高度上下调整
Adjusting Ciamp(Iron)
Type Number:
NG05013(galvanizing)
NG05013(painting)
Using to connect between
bracketand mud guard it can be
adjusted to the height from top
to botten

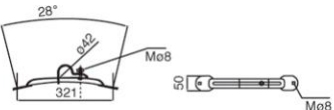

NG045100

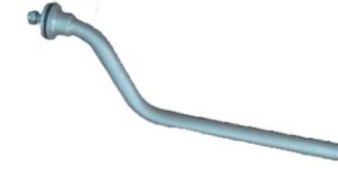

挡泥罩支架

材料: 钢
重量: 2.0kg
表面处理: 镀锌
Material:steel
Weight:2.0kg
Finish:zinc

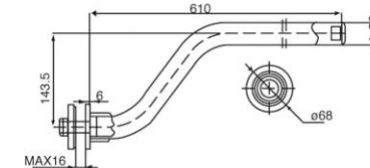

NG05014



挡泥罩支架(铁)

型号: NG05014(锌Φ42/38)
用途: 连接挡泥罩和压板, 可调节
角度
Bracket(Strent Tube)Iron
Type Number:
NG05014(galvanizing)
Application:Connecting to the
mud guard and clamp it can
adjust the angle

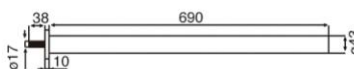

NG05015



挡泥罩支架(浇筑底座)

型号: NG05015
用途: 连接挡泥罩和压板。
Bracket(Strent Tube)Iron
Type Number:
Application:Connecting to the
mud guard and clamp it can
adjust the angles

NG15001

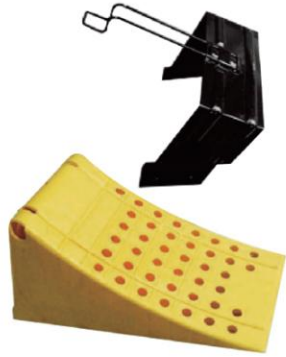

挡车器

型号: NG15001
描述: 适用于车辆维修停在下坡或上坡时放于车轮下装置。
Blocking Device
Type Number: NG15001
Description: Suitale for vehicle repair stop in the downhill, uphill for blocking the wheel of the device

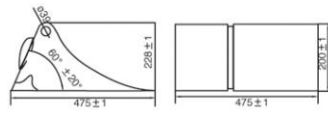

NG15002



挡车器

型号: NG15002
描述: 适用于车辆维修停在下坡或上坡时放于车轮下装置。
Blocking Device
Type Number: NG15002
Description: Suitale for vehicle repair stop in the downhill, uphill for blocking the wheel of the device

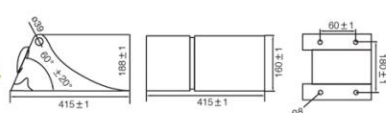

NG15003



挡车器

型号: NG15003
描述: 适用于车辆维修停在下坡或上坡时放于车轮下装置。
Blocking Device
Type Number: NG15003
Description: Suitale for vehicle repair stop in the downhill, uphill for blocking the wheel of the device

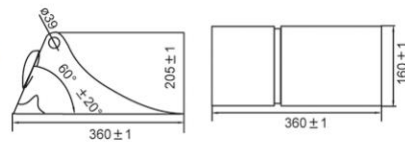

NG15004



挡车器

型号: NG15004
描述: 适用于车辆维修停在下坡或上坡时放于车轮下装置。
Blocking Device
Type Number: NG15004
Description: Suitale for vehicle repair stop in the downhill, uphill for blocking the wheel of the device

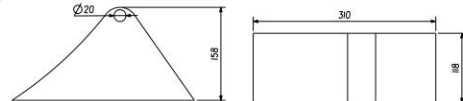

NG15005



挡车器

型号: NG15005
描述: 适用于车辆维修停在下坡或上坡时放于车轮下装置。
Blocking Device
Type Number: NG15005
Description: Suitale for vehicle repair stop in the downhill, uphill for blocking the wheel of the device

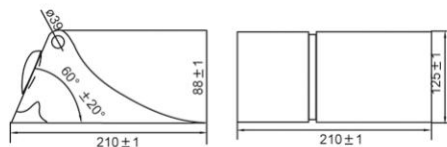

NG15006



挡车器

型号: NG15006(085100)
描述: 适用于车辆维修停在下坡或上坡时放于车轮下装置。
Blocking Device
Type Number: NG15004(085100)
Description: Suitale for vehicle repair stop in the downhill, uphill for blocking the wheel of the device

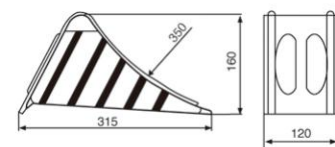

防撞块

规格:
① 150x75x85
② 160x50x60
③ Φ 50

Collosion Chock
Specification:

① 150x75x85
② 160x50x60
③ Φ 50

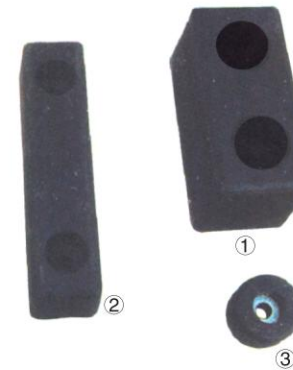

防爆油罐车线束 防护等级: IP65

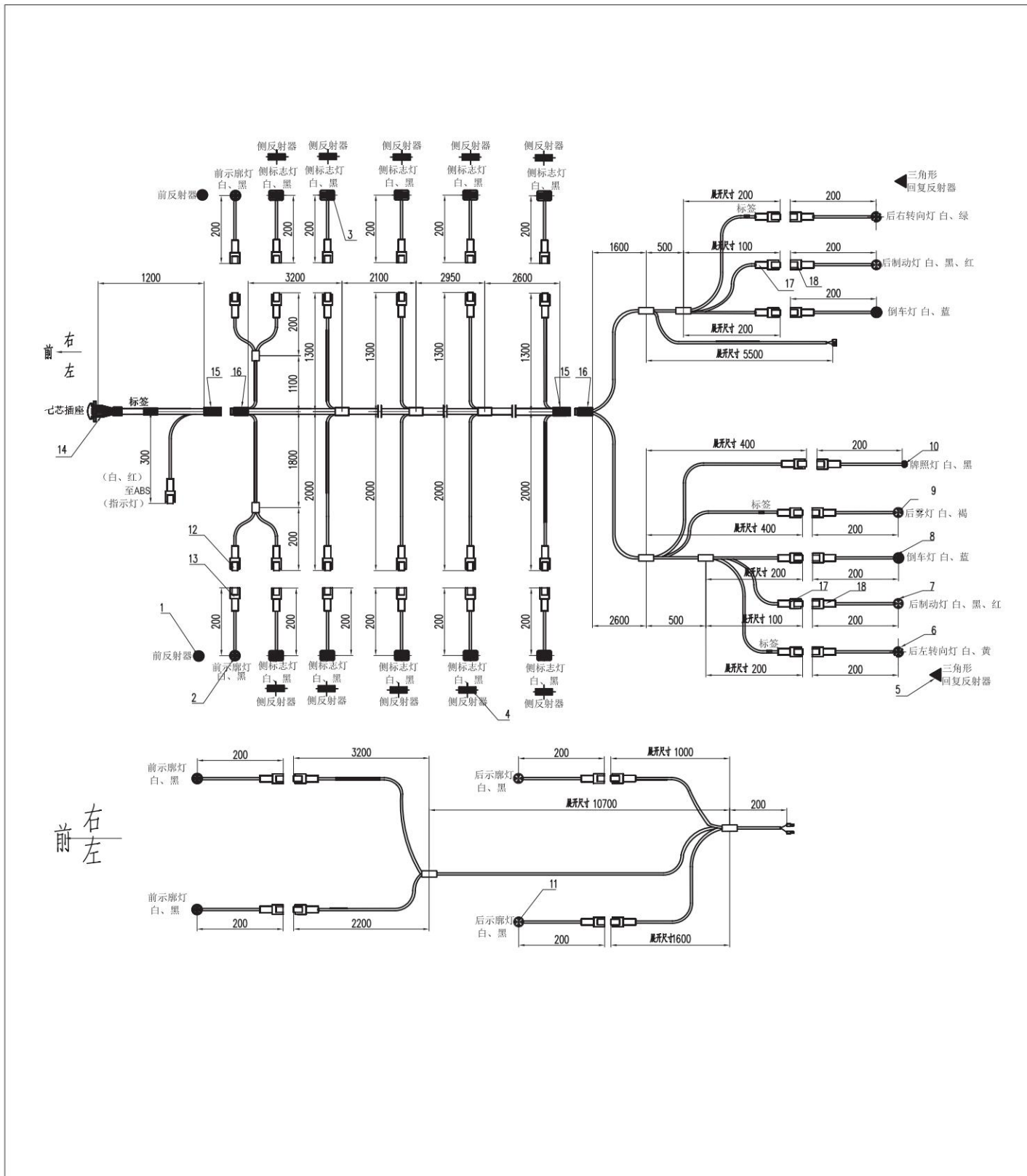

罐车线束

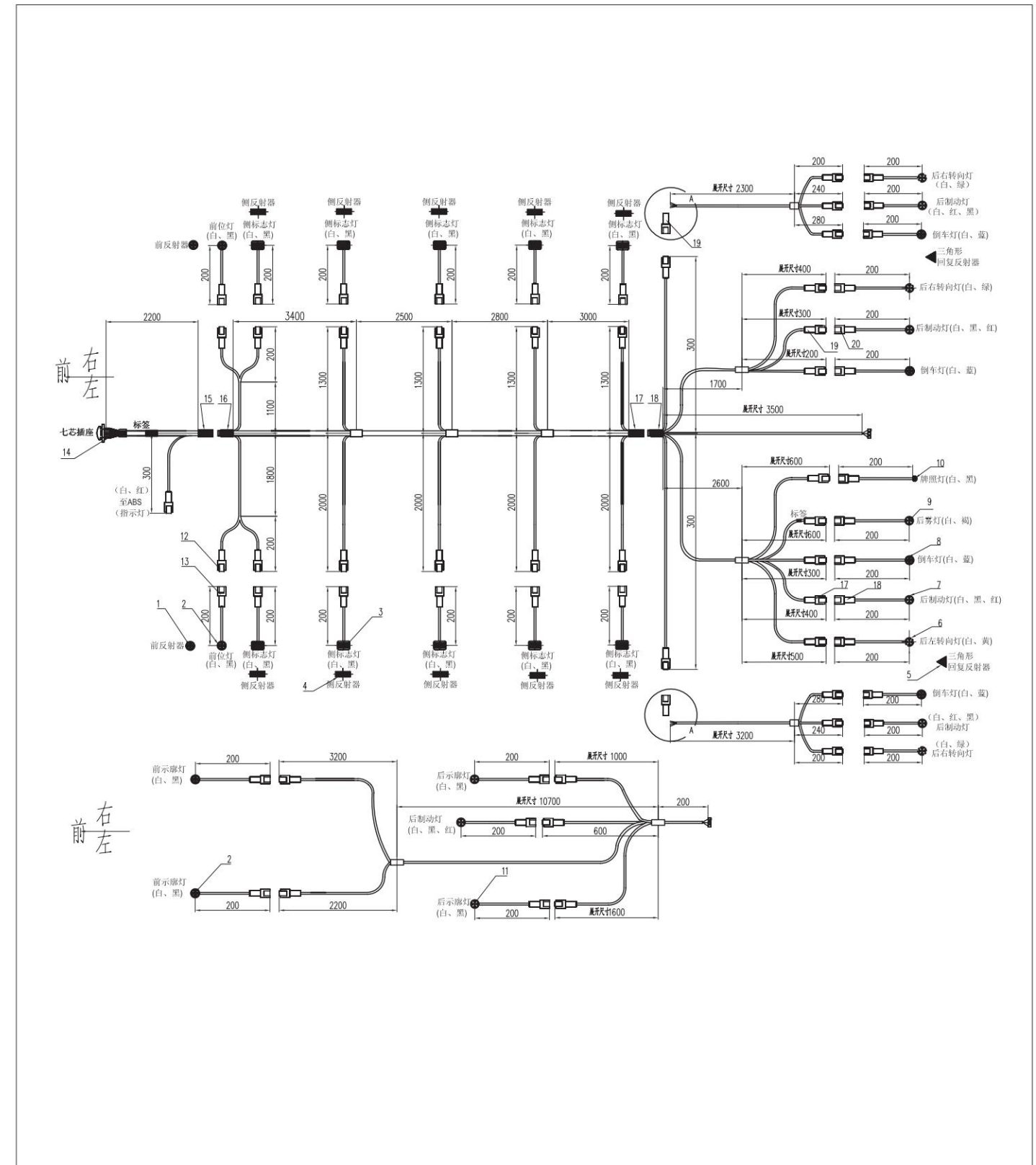

环卫车线束

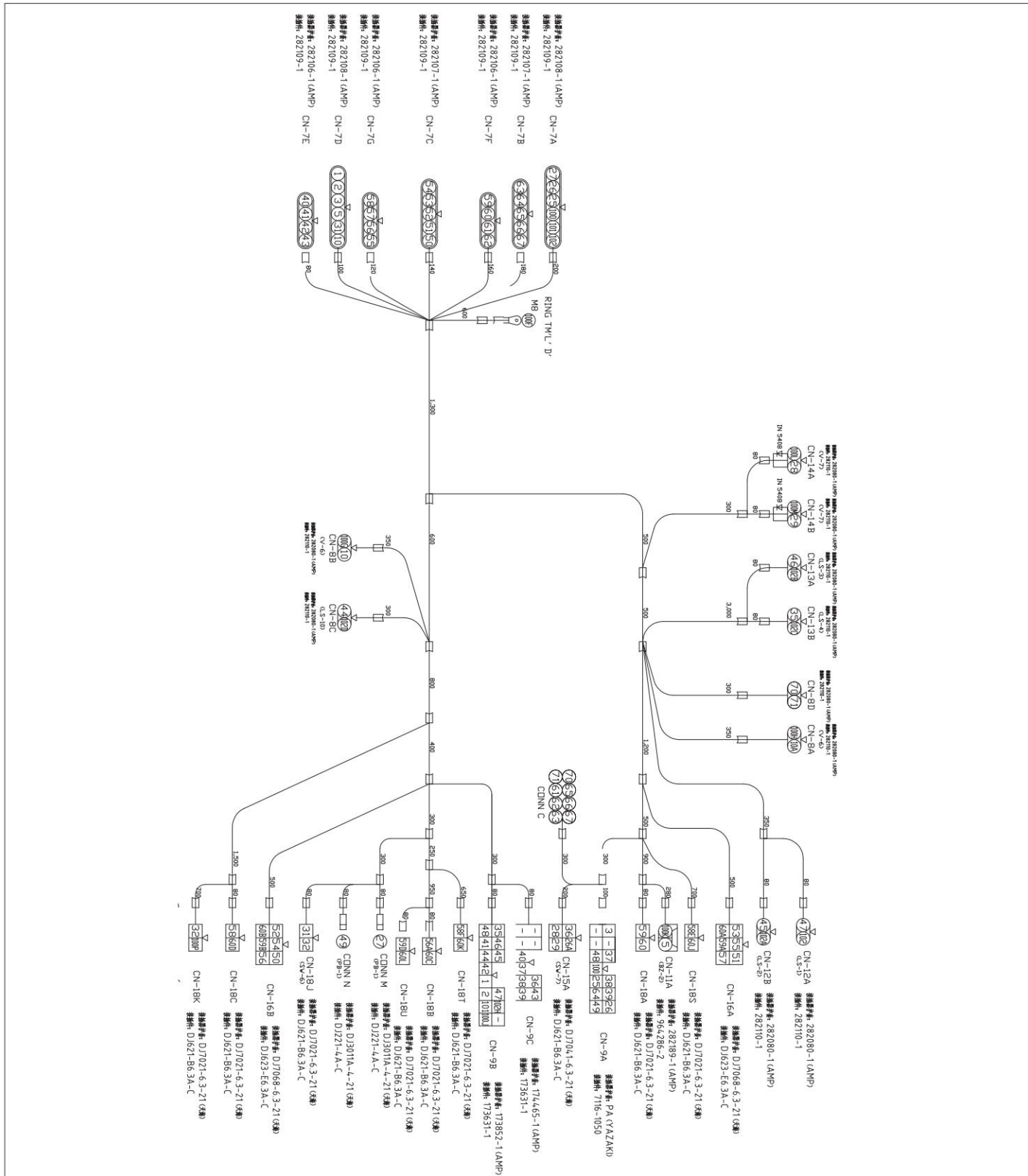

环卫车线束

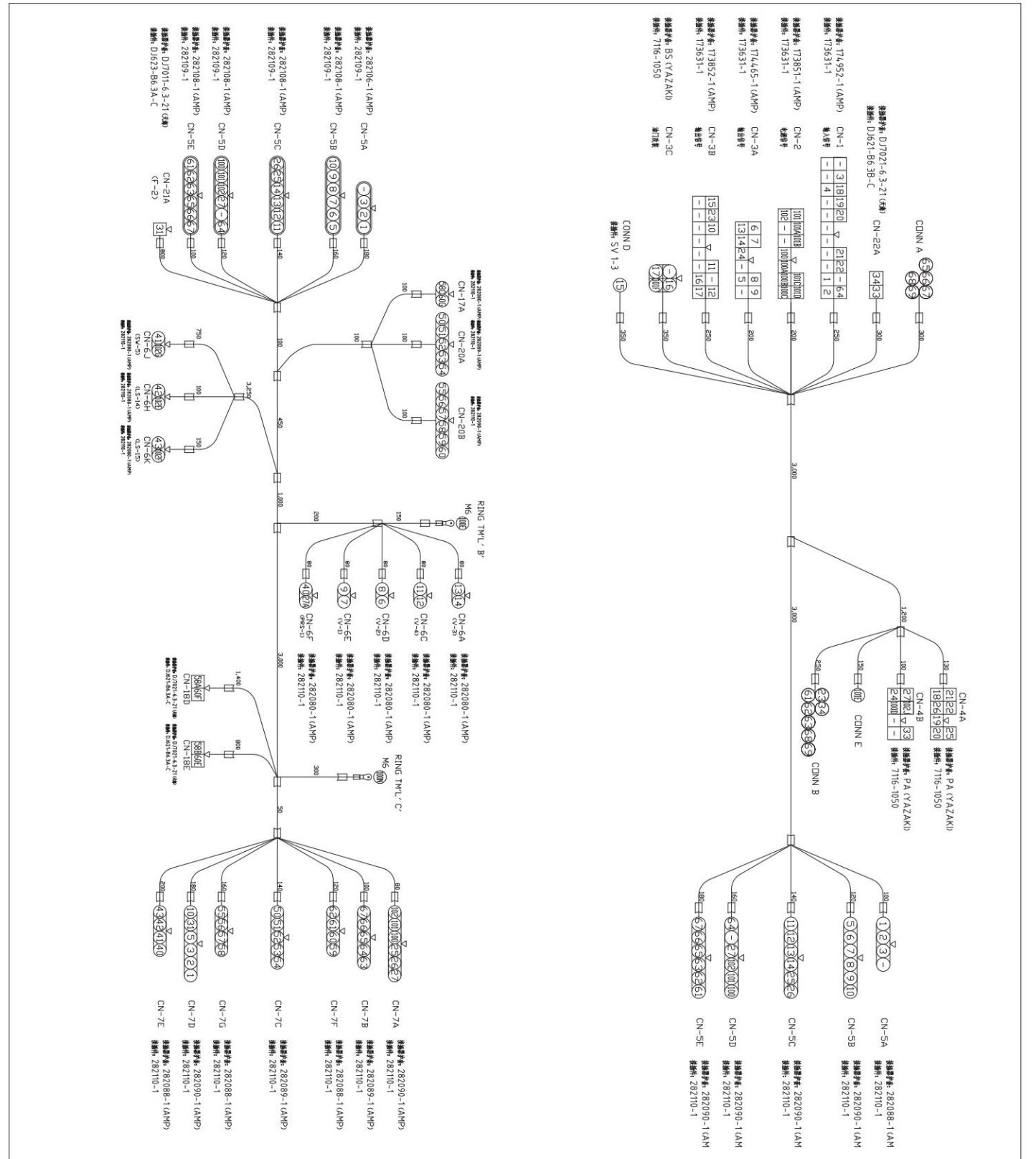



一体式插头
规格: 二芯、三芯
汽车专用电缆
规格: 二芯、三芯、五芯、七芯

Integrated Plug
Specification:
Two Core Male/Female
Three Core Male/Female
Integrated Plug
Specification:
Two Core/ Three Core
Five Core/ Seven Core



开口波纹管
规格: $\Phi 6$ 、 $\Phi 9$ 、 $\Phi 11$ 、 $\Phi 13$ 、 $\Phi 20$ 、 $\Phi 30$ 等

Opening Bellow
Specification: $\Phi 6$ 、 $\Phi 9$ 、 $\Phi 11$ 、 $\Phi 13$ 、 $\Phi 20$ 、 $\Phi 30$



过线圈
规格: $\Phi 25 \times 6.5$
 $\Phi 25 \times 12$
 $\Phi 38 \times 6.5$
 $\Phi 38 \times 12$

Coli
Specification:
 $\Phi 25 \times 6.5$
 $\Phi 25 \times 12$
 $\Phi 38 \times 6.5$
 $\Phi 38 \times 12$



插头
规格:
①七芯插头
②七芯插座

Specification:
①Seven core plug
②Seven core Receptacle

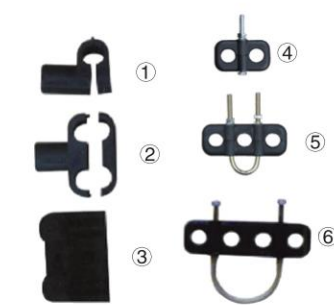

气管夹 Trzchea Folder
规格: Trzchea Folder:
①1x12 ①1x12
②2x12 ②2x12
③2x12 ③2x12
④2x17 ④2x17
⑤3x12 ⑤3x12
⑥4x17 ⑥4x17

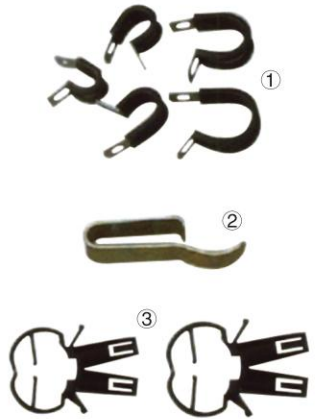

线夹
规格:
①不锈钢线夹 $\Phi 8/12/16/20/24$
②钢线夹
③尼龙线夹 $\Phi 12/24$

Wire clamp
Specification:
①SUS Clamp
②Steel Clamp
③Nylon Clamp

NG06001



牌照灯(泡式)
型号: NG06001
用途: 用于照明牌照板的装置。
灯泡型号: R10W (24V10W)
3C认证产品
License Plate Lamp
Type Number:NG06001
Application: Using the license plate for lighting devices
Bulb Mode:R10W (24V10W)
3C Authentication

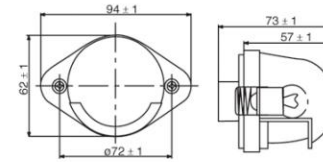

NG06002



牌照灯(泡式)
型号: NG06002
用途: 用于照明牌照板的装置。
灯泡型号: R10W (24V10W)
3C认证产品
License Plate Lamp
Type Number:NG06002
Application: Using the license plate for lighting devices
Bulb Mode:R10W (24V10W)
3C Authentication

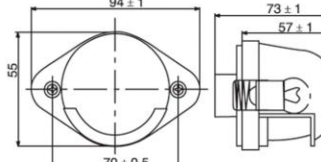

NG06003



长2寸牌照灯(泡式)
型号: NG06003
用途: 用于照明牌照板的装置。
灯泡型号: W5W (24V5W)
3C认证产品
License Plate Lamp
Type Number:NG06003
Application: Using the license plate for lighting devices
Bulb Mode:W5W (24V5W)
3C Authentication

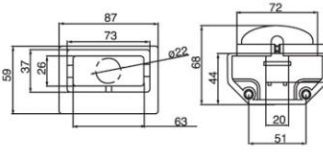

NG07001W(白)/NG07001R(红)



前后示廓灯/前后位灯(泡式)
型号: NG07001W/NG07001R
用途: 安装在车辆最外沿和可能靠近最顶部附近, 用来表明车宽和高灯具。
灯泡型号: R10W (24V10W)
3C认证产品
F/R Clearance lamp/Parking lights
Type Number:NG07001W/NG07001R
Application: Fixed on the vehicle near the outer height and width of lamps
Buld Mode:R10(24V10W)
3C Authentication

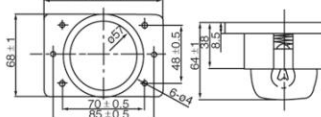

NG07002W(白)/NG07002R(红)



前后示廓灯(泡式)
型号: NG07002W/NG07002R
用途: 安装在车辆最外沿和可能靠近最顶部附近, 用来表明车宽和高灯具。
灯泡型号: W5W (24V5W)
3C认证产品
F/R Clearance lamp
Type Number:NG07002W/NG07002R
Application: Fixed on the vehicle near the outer height and width of lamps
Buld Mode:W5W(24V5W)
3C Authentication

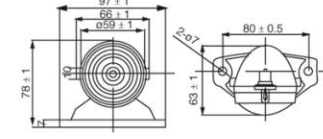

NG07003W(白)/NG07003R(红)



前后示廓灯/前后位灯(泡式)
型号: NG07003W/NG07003R
用途: 安装在车辆最外沿和可能靠近最顶部附近, 用来表明车宽和高灯具。
灯泡型号: R10W (24V10W)
3C认证产品
F/R Clearance lamp/Parking lights
Type Number:NG07003W/NG07003R
Application: Fixed on the vehicle near the outer height and width of lamps
Buld Mode:R10W (24V10W)
3C Authentication

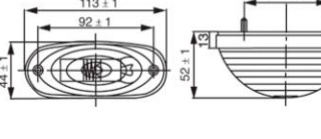

NG07004(凸)



前后示廓灯(泡式)

型号: NG07004(凸)
用途: 安装在车辆最外沿和可能靠近最顶部附近, 用来表明车宽和高灯具。
灯泡型号: W5W (24V5W)
3C认证产品
F/R Clearance lamp
Type Number: NG07004(Convex)
Application: Fixed on the vehicle near the outer height and width of lamps
Buld Mode: W5W(24V5W)
3C Authentication

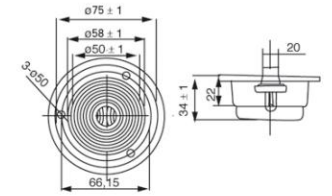

NG07004(凹)

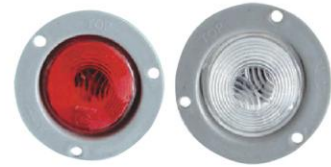

前后示廓灯(泡式)

型号: NG07004(凹)
用途: 安装在车辆最外沿和可能靠近最顶部附近, 用来表明车宽和高灯具。
灯泡型号: W5W (24V5W)
3C认证产品
F/R Clearance lamp
Type Number: NG07004(Concave)
Application: Fixed on the vehicle near the outer height and width of lamps
Buld Mode: W5W(24V5W)
3C Authentication

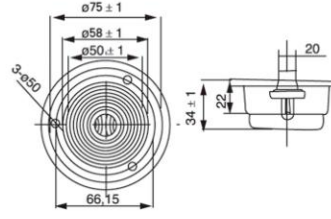

NG08001



倒车灯(泡式)

型号: NG08001
用途: 照明车辆后方道路和其它道路的使用情况, 表明车辆正在和即将倒车的灯。
灯泡型号: P21W (24V21W)
3C认证产品
Backup Lamp
Type Number: NG08001
Application: Lighting vehicle rear roads and other roads The use of vehicles indicates that the vehicle is reversing
Auto lamp.
Buld Mode: P21W (24V21W)
3C Authentication

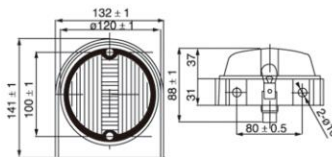

NG08002



倒车灯(泡式)

型号: NG08002
用途: 照明车辆后方道路和其它道路的使用情况, 表明车辆正在和即将倒车的灯。
灯泡型号: P21W (24V21W)
3C认证产品
Backup Lamp
Type Number: NG08002
Application: Lighting vehicle rear roads and other roads The use of vehicles indicates that the vehicle is reversing
Auto lamp.
Buld Mode: P21W (24V21W)
3C Authentication

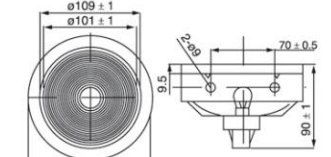

NG08010



后雾灯(泡式)

型号: NG08010
用途: 在大雾的情况下, 从车辆后面观察, 表明车辆的行驶位置, 使得车辆更为易见。
灯泡型号: P21W (24V21W)
3C认证产品
Rear Fog Lamp
Type Number: NG08010
Application: In the circumstances, the observation from the Rear of Vehicles Vehicle makes it easier to see the lights
Buld Mode: P21W (24V21W)
3C Authentication

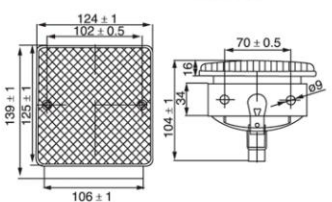

NG08011



后雾灯(泡式)

型号: NG08011
用途: 在大雾的情况下, 从车辆后面观察, 表明车辆的行驶位置, 使得车辆更为易见。
灯泡型号: P21W (24V21W)
3C认证产品
Rear Fog Lamp
Type Number: NG08011
Application: In the circumstances, the observation from the Rear of Vehicles Vehicle makes it easier to see the lights
Buld Mode: P21W (24V21W)
3C Authentication

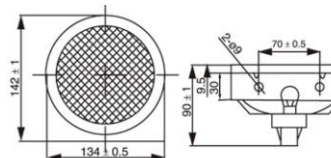

NG08020

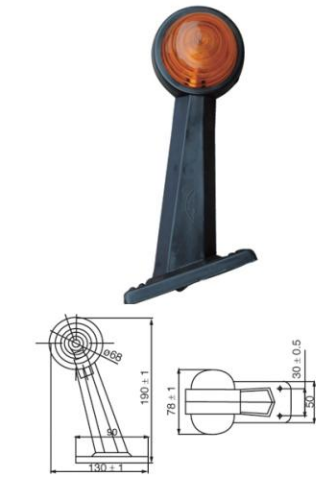

侧向信号灯

型号: NG08020
用途: 用于车辆侧面, 表明车辆向左或向右转向的灯具
灯泡型号: P21W/5W (21V21/5W)
3C认证产品
Side Signal Lamp
Type Number: NG08020
Application: For vehicle side, shown the vehicle the left of right lamps
Buld Mode: P21W/5W (21V21/5W)
3C Authentication

NG08040



工作灯(泡式)

型号: NG08040
用途: 表明车辆有作业, 也可以作为倒车时的辅助灯具, 可以上下左右调节角度。
灯泡型号: H3、24V55W、12V55W
Work Lamp
Type Number: NG08040
Application: Indicating that the vehicle is in operation and reversing auxiliary lamps, lamps can be up and down around the angle adjustment.
Buld Mode: H3、24V55W、12V55W

NG08041



工作灯(泡式)

型号: NG08041
用途: 表明车辆有作业, 也可以作为倒车时的辅助灯具, 可以上下左右调节角度。
灯泡型号: R224281、24V55/50W
Work Lamp
Type Number: NG08041
Application: Indicating that the vehicle is in operation and reversing auxiliary lamps, lamps can be up and down around the angle adjustment.
Buld Mode: R224281、24V55/50W

NG09001 NG09002



2寸圆灯、安装环

型号: NG09001 (前位灯)
NG09002 (后位灯)
NG09003 (侧标志灯)
NG09004 (安装环)
用途: 前后示廓灯、前后位灯、侧标志灯。
3C认证产品
2" Round Lamp/Erection loop
Application: F/R Outline Marker lamp, F/R Position lamp and side signal lamp
3C Authentication

NG09011 NG09012



2.5寸圆灯(带反射器)、安装环

型号: NG09011 (前位灯)
NG09012 (后位灯)
NG09013 (侧标志灯)
NG09017 (安装环)
用途: 前后示廓灯、前后位灯、侧标志灯。
灯泡型号: W5W (24V5W)
3C认证产品
2.5" Round Lamp/Erection loop
Application: F/R Outline Marker lamp, F/R Position lamp and side signal lamp
3C Authentication

NG09021 NG09022



4寸圆灯、安装环

型号: NG09021 (制动/后位)
NG09022 (倒车) NG09023 (转向)
NG09024 (后雾) NG09025 (安装环)
用途: 具有制动/后位、转向、倒车、后雾灯功能, 具有牢固性、密封性、抗震的特点。
灯泡型号: P21W (24V21W)
3C认证产品
4" Round Lamp/Erection loop
Application: Having a break/rear position, turning, reversing, rear fog lamp with firmness. the seal the asseismatic function.
3C Authentication

NG09031



前示廓灯

型号: NG09031
用途: 前示廓灯
3C认证产品
Front Clearance lamp
Type Number:NG09031
Application:With the functions of front&rear marker lamp and side signal lamp.
3C Authentication

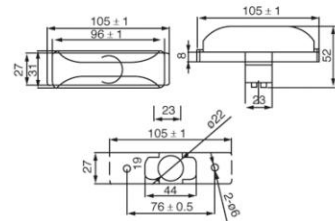

NG09032

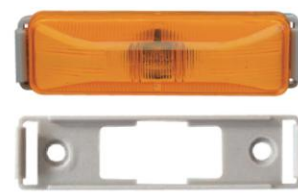

侧标志灯

型号: NG09032
用途: 侧标志灯
3C认证产品
Side Marker lamp
Type Number:NG09032
Application:With the functions of front&rear marker lamp and side signal lamp.
3C Authentication

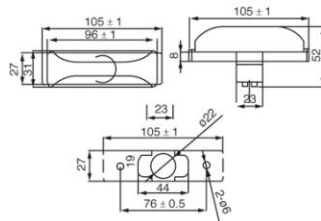

NG09033



后示廓灯

型号: NG09033
用途: 后示廓灯
Rear Clearance lamp
Type Number:NG09033
Application:With the functions of front&rear marker lamp and side signal lamp.

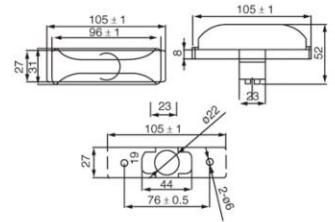

NG09040



6寸椭圆灯(泡式)

型号: NG09040
用途: 侧转向灯、侧标志灯、侧反射器
3C认证产品
6"Elliptic lamp
Type Number:NG09040
Application:With the functions of side turn lamp,side signal lamp and side reflector
3C Authentication

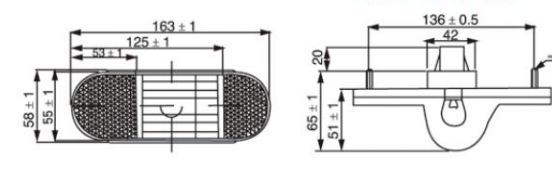

NG09051



型号: NG09051(灯泡式)
用途: 汽车后位/制动灯
3C认证产品

Type Number:NG09051
3C Authentication

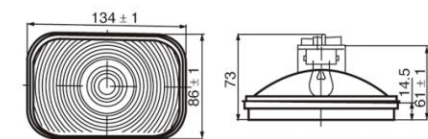

NG09052



型号: NG09052(灯泡式)
用途: 汽车转向灯
3C认证产品

Type Number:NG09052
3C Authentication

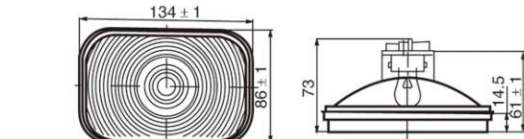

NG09053



型号: NG09053(灯泡式)
用途: 汽车倒车灯
3C认证产品

Type Number:NG09053
3C Authentication

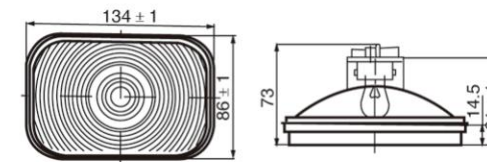

NG09054



型号: NG09054(灯泡式)
用途: 汽车后雾灯
3C认证产品

Type Number:NG09054
3C Authentication

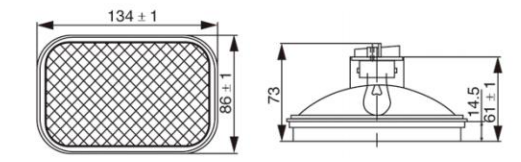

NG09110 NG09112



2寸LED灯、安装环
型号: NG09110(前示廓灯)/3C认证
NG09112(后示廓灯)/3C/E-mark认证
NG09111(侧标志灯)/3C认证
NG09004(2寸安装环)
2" Lamp/Erection loop
Type Number:
NG09110(F.Clearance lamp)/
3C Authentication
NG09112(R.Clearance lamp)/
3C Authentication/E-mark Authentication
NG09111(Side Signal lamp)/
3C Authentication
NG09004(2"Erection loop)

NG09111 NG09004



NG09116



制动/后位
型号: NG09116 (制动/后位)
NG09025 (安装环)
性能: LED具有高亮度、功率低、
密封性好、寿命长、100%防水
性等特点。
LED数量: 56 电压: 24V
3C认证产品
Type Number: NG09116、NG09025
Description: With the functions of stop
lamp,Rear position lamp and turn lamp
LED hashigh brightness,low power,
good sealing and long life,
100% waterproof.
LED quantity: 56
Voltage: 24V
3C Authentication

NG09025

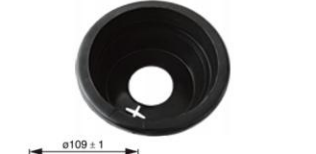

NG09118



4寸LED圆灯(倒车灯)
型号: NG09118 (倒车)
NG09025 (安装环)
性能: LED具有高亮度、功率低、
密封性好、寿命长、100%防水
性等特点。
LED数量: 56 电压: 24V
3C认证产品
4" Round lamp LED
Type Number: NG09118、NG09025
Description: With the functions of stop
lamp,Rear position lamp and turn lamp
LED hashigh brightness,low power,
good sealing and long life,
100% waterproof.
LED quantity: 56 Voltage: 24V
3C Authentication

NG09025



NG09125 NG09115



**2.5寸LED圆灯(带反射器)
安装环 (可带法兰盘)**
型号: NG09125 (前位灯带反射器)
NG09114 (侧标志灯)
NG09115 (后示廓灯)
NG09017 (2.5寸安装环)
3C认证产品
2.5" Round lamp/Erection loop
Type Number:
NG09125 (F.Lamp With reflector)
NG09114 (Side marker lamps)
NG09115 (R.Clearance lamp)
NG09017 (2.5" Erection loop)
3C Authentication

NG09114 NG09017



NG09117



4寸LED圆灯(转向灯)
型号: NG09117 (转向)
NG09025 (安装环)
性能: LED具有高亮度、功率低、
密封性好、寿命长、100%防水
性等特点。
LED数量: 56 电压: 24V
3C认证产品
4" Round lamp LED
Type Number: NG09117、NG09025
Description: With the functions of stop
lamp,Rear position lamp and turn lamp
LED hashigh brightness,low power,
good sealing and long life,
100% waterproof.
LED quantity: 56 Voltage: 24V
3C Authentication

NG09025



NG09119



4寸LED圆灯(后雾灯)
型号: NG09119 (后雾)
NG09025 (安装环)
性能: LED具有高亮度、功率低、
密封性好、寿命长、100%防水
性等特点。
LED数量: 56 电压: 24V
3C认证产品
4" Round lamp LED
Type Number: NG09118、NG09025
Description: With the functions of stop
lamp,Rear position lamp and turn lamp
LED hashigh brightness,low power,
good sealing and long life,
100% waterproof.
LED quantity: 56 Voltage: 24V
3C Authentication

NG09025



NG09120Y



长4寸LED灯
型号: NG09120Y
用途: 侧标志灯
LED数量: 6 电压: 24V
3C认证产品
4" Rectangle lamp LED
Type Number:NG09120Y
Application: With the function of front&
rear marker lamp and side signal lamp
LED quantity:6 Voltage:24V
3C Authentication

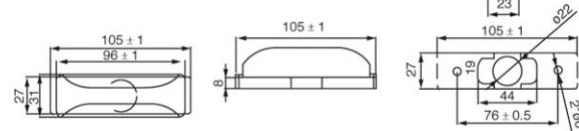

NG09122R



长4寸LED灯
型号: NG09122R
用途: 后示廓灯
LED数量: 6 电压: 24V
3C认证产品
4" Rectangle lamp LED
Type Number:NG09120R
Application: With the function of front&
rear marker lamp and side signal lamp
LED quantity:6 Voltage:24V
3C Authentication

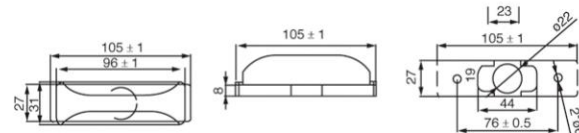

NG09124



侧标志灯/LED
型号: NG09124
用途: 侧转向灯、侧标志灯、侧反射器
的功能, 具有超高亮度、强耐化学性、
100%防水性的特点。
LED数量: 24 电压: 24V
3C认证产品
2"x6" Ellipse lamp LED
Type Number:NG09124
Application: With the side turn lamp,
side signal lamp and side reflector.
24pcs super bright Flux LED with UV
polycarbonate lens for enhanced
chemical resistance 100% waterproof.
LED quantity:24 Voltage:24V
3C Authentication

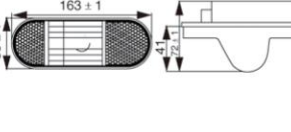

NG09121W



长4寸LED灯
型号: NG09121W
用途: 示廓灯
LED数量: 6 电压: 24V
3C认证产品
4" Rectangle lamp LED
Type Number:NG09120W
Application: With the function of front&
rear marker lamp and side signal lamp
LED quantity:6 Voltage:24V
3C Authentication

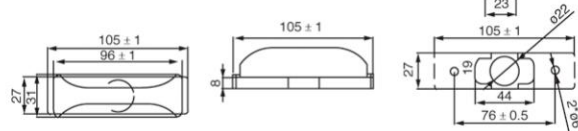

NG09123



长2寸LED牌照灯
型号: NG09123
用途: 照明牌照板的装置, 采用6颗
LED, 具有超高亮度、强耐化学性、
100%防水性的特点。
LED数量: 6 电压: 24V
3C认证产品 E-mark认证产品
2" Rectangle License plate lamp LED
Type Number:NG09123
Application: Using the license plate for
lighting devices 6 pcs super bright
Flux LED with UV polycarbonate lens
for enhanced chemical resistance
100% waterproof.
LED quantity:6 Voltage:24V
3C Authentication
E-markAuthentication

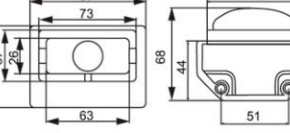

NG09130



侧标志灯/LED
型号: NG09130
用途: LED侧标志灯, 带回复反射器
电压: 24V
3C认证产品 E-mark认证产品
Type Number:NG09130
Application: LED side marker lights,
With Reflector.
Voltage:24V
3C Authentication
E-markAuthentication

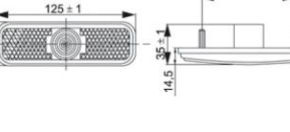

NG09131

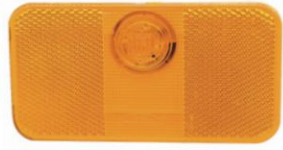

侧标志灯/LED

型号: NG09131
用途: LED侧标志灯, 带回复反射器
电压: 24V
3C认证产品
Type Number: NG09131
Application: LED side marker lights, with side reflector
Voltage: 24V
3C Authentication

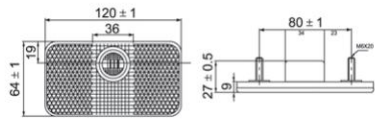

NG09132



侧标志灯/LED

型号: NG09132
用途: LED侧标志灯, 带回复反射器
LED数量: 5 电压: 24V
3C认证产品
Type Number: NG09132
Application: LED side marker lights, with side reflector
LED quantity: 5
Voltage: 24V
3C Authentication

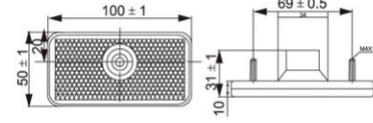

NG09140



侧标志灯/LED

型号: NG09140
用途: LED侧标志灯, 带反射器、照地
描述: LED具有高亮度、功率低、密封性好、寿命长, 100%防水性的特点。
LED数量: 22 电压: 24V
3C认证产品
Side Lamp LED
Type Number: NG09140
Description: LED has high brightness, low power, good sealing and long life, 100% waterproof.
LED quantity: 22 Voltage: 24V
3C Authentication

NG09135



牌照灯/LED

型号: NG09135
用途: 采用6颗LED, 具有超高亮度、强耐化学性、100%防水性的特点。
LED数量: 6 电压: 24V
3C认证产品
License Plate lamp
Type Number: NG09135
Description: 6pcs super bright Flux LED with UV Polycarbonate lens for enhanced chemical resistance 100% waterproof.
LED quantity: 6 Voltage: 24V
3C Authentication

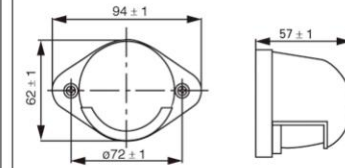

NG09133



侧标志灯/LED

型号: NG09133
用途: LED侧标志灯, 带回复反射器
电压: 24V
3C认证产品
Type Number: NG09133
Application: LED side marker lights, with side reflector
Voltage: 24V
3C Authentication

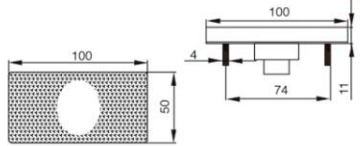

NG09207



侧标志灯/LED

型号: NG09207
用途: LED侧标志灯, 带反射器
描述: LED具有高亮度、功率低、密封性好、寿命长, 100%防水性的特点。
LED数量: 6 电压: 24V
3C认证产品
Side Lamp LED
Type Number: NG09207
Description: LED has high brightness, low power, good sealing and long life, 100% waterproof.
LED quantity: 6 Voltage: 24V
3C Authentication

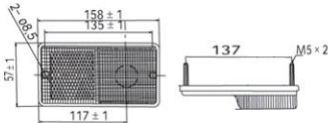

NG09136



牌照灯/LED

型号: NG09136
性能: 采用6颗LED, 具有超高亮度、强耐化学性、100%防水性的特点。
LED数量: 6 电压: 24V
3C认证产品
License Plate lamp
Type Number: NG09136
Description: 6 pcs super bright Flux LED with UV polycarbonate lens for enhanced chemical resistance 100% waterproof.
LED quantity: 6 Voltage: 24V
3C Authentication

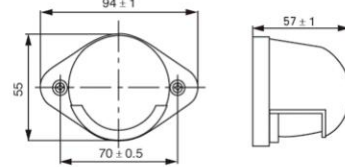

NG09201



后组合灯LED

型号: NG09201 (由NG09125/126组成)
用途: 具有制动灯、后位灯、转向灯的功能, LED具有高亮度、功率低、密封性好、寿命长等特点。
LED数量: 56/56 电压: 24V
3C认证产品
Tail Lamps
Type Number: NG09201
Application: With the function of stop lamp, rear position lamp and turn lamp LED has high brightness, low power, good sealing and long life, 100% waterproof.
LED quantity: 56/56 Voltage: 24V
3C Authentication

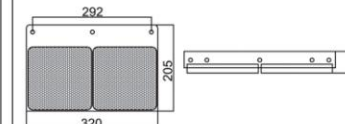

NG09207-1

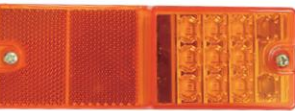

侧标志灯/LED

型号: NG09207-1
用途: LED侧标志灯, 带反射器
描述: LED具有高亮度、功率低、密封性好、寿命长, 100%防水性的特点。
LED数量: 9 电压: 12/24V
3C认证产品
Side Lamp LED
Type Number: NG09207-1
Description: LED has high brightness, low power, good sealing and long life, 100% waterproof.
LED quantity: 9 Voltage: 12/24V
3C Authentication

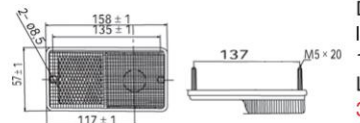

NG09207-2



侧标志灯/LED (灌胶款)

型号: NG09207-2
用途: LED侧标志灯, 侧转向带反射器
描述: LED具有高亮度、功率低、密封性好、寿命长, 100%防水性的特点。
LED数量: 9 电压: 12/24V
3C认证产品
Side Lamp LED
Type Number: NG09207-2
Description: LED has high brightness, low power, good sealing and long life, 100% waterproof.
LED quantity: 9 Voltage: 12/24V
3C Authentication



NG09202



后组合灯LED

型号: NG09202 (由NG09116/117组成)
用途: 具有制动灯、后位灯、转向灯的功能, LED具有高亮度、功率低、密封性好、寿命长等特点。
LED数量: 56/56 电压: 24V
3C认证产品
Tail Lamps
Type Number: NG09202
Application: With the function of stop lamp, rear position lamp and turn lamp LED has high brightness, low power, good sealing and long life, 100% waterproof.
LED quantity: 56/56 Voltage: 24V
3C Authentication



NG09202-1



后组合灯LED

型号: NG09202-1 (由NG09116/117/118组成)
用途: 具有制动灯、后位灯、转向灯、倒车灯的功能, LED具有高亮度、功率低、密封性好、寿命长等特点。
LED数量: 56/56/56 电压: 24V
3C认证产品
Tail Lamps
Type Number: NG09202-1
Application: With the function of stop lamp, rear position lamp and turn lamp LED has high brightness, low power, good sealing and long life, 100% waterproof.
LED quantity: 56/56/56 Voltage: 24V
3C Authentication

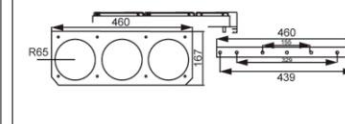

NG09203-1



后组合灯LED

型号: NG09203-1
(由NG09125/126/127组成)
用途: 具有制动灯、后位灯、转向灯、倒车灯的功能, LED具有高亮度、功率低、密封性好、寿命长等特点。
电压: 24V

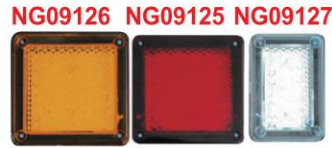

3C认证产品
Rear Fog lamp LED
Type Number:NG09203-1
Application: LED has high brightness, low power,good sealing and long life, 100% waterproof.
Voltage:24V
3C Authentication

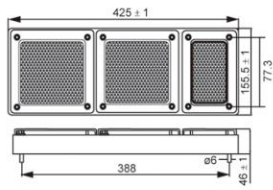

NG09203-2



后组合灯LED

型号: NG09203-2
(由NG09128/129/130组成)
用途: 具有制动灯、后位灯、转向灯、倒车灯的功能, LED具有高亮度、功率低、密封性好、寿命长等特点。
电压: 24V

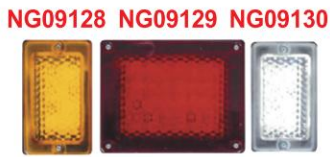

3C认证产品
Rear Fog lamp LED
Type Number:NG09203-2
Application: LED has high brightness, low power,good sealing and long life, 100% waterproof.
Voltage:24V
3C Authentication

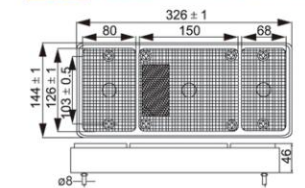

NG09203-3



后组合灯LED

型号: NG09203-3
(由NG09128/129/130组成)
用途: 具有制动灯、后位灯、转向灯、倒车灯的功能, LED具有高亮度、功率低、密封性好、寿命长等特点。
电压: 24V



3C认证产品
Rear Fog lamp LED
Type Number:NG09203-3
Application: LED has high brightness, low power,good sealing and long life, 100% waterproof.
Voltage:24V
3C Authentication

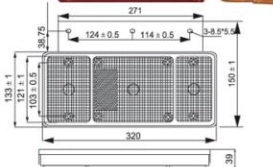

NG09307



后组合灯LED

型号: NG09307
(由NG09151制动、后位/NG09152转向/NG09153倒车组成)
用途: 具有制动灯、后位灯、转向灯、倒车灯的功能, LED具有高亮度、功率低、密封性好、寿命长等特点。
LED数量: 40/40/40 电压: 24V



3C认证产品
Tail Lamps Type Number:NG09307
Application: With the function of stop lamp, rear position lamp and turn lamp
LED has high brightness, low power, good sealing and long life, 100% waterproof.
LED quantity:40/40/40 Voltage:24V
3C Authentication

NG09308



后组合灯LED

型号: NG09308
(由NG09161制动、后位/NG09162转向/NG09163倒车组成)
用途: 具有制动灯、后位灯、转向灯、倒车灯的功能, LED具有高亮度、功率低、密封性好、寿命长等特点。
LED数量: 24/24/24 电压: 24V



3C认证产品
Tail Lamps Type Number:NG09308
Application: With the function of stop lamp, rear position lamp and turn lamp
LED has high brightness, low power, good sealing and long life, 100% waterproof.
LED quantity:24/24/24 Voltage:24V
3C Authentication

NG09309



后组合灯LED

型号: NG09309
用途: 具有制动灯、后位灯、转向灯、后雾灯、倒车灯的功能, LED具有高亮度、功率低、密封性好、寿命长等特点。
电压: 24V

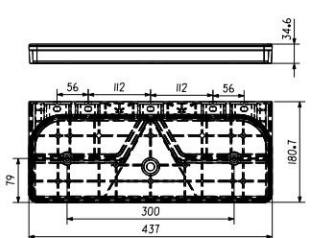

Tail Lamps Type Number:NG09309
Application: With the function of stop lamp, Rear Fog lamp rear position lamp and turn lamp.
LED has high brightness, low power, good sealing and long life, 100% waterproof.
Voltage:24V

NG09310



后组合灯LED

型号: NG09310
用途: 具有制动灯、后位灯、转向灯、后雾灯、倒车灯的功能, LED具有高亮度、功率低、灌胶密封、寿命长等特点。
电压: 24V

Tail Lamps Type Number:NG09309
Application: With the function of stop lamp, Rear Fog lamp rear position lamp and turn lamp.
LED has high brightness, low power, good sealing and long life, 100% waterproof.
Voltage:24V

NG09156



4寸LED制动/后位灯

型号: NG09156(制动/后位)
(原NG09222)
描述: LED具有高亮度、功率低、密封性好、寿命长、100%防水等特点。
LED数量: 24
电压: 24V

3C认证产品
4" Tail Lamps
Type Number:NG09156
Description: LED has high brightness, low power, good sealing and long life 100% waterproof.
LED quantity:24 Voltage:24V
3C Authentication



NG09157



4寸LED转向灯

型号: NG09157(转向)
(原NG09222)
描述: LED具有高亮度、功率低、密封性好、寿命长、100%防水等特点。
LED数量: 24 电压: 24V

3C认证产品
4" Tail lamp
Type Number: NG09157
Description: LED has high brightness, low power, good sealing and long life, 100% waterproof.
LED quantity: 24 Voltage: 24V
3C Authentication



NG09158



4寸LED倒车灯

型号: NG09158(倒车)
(原NG09222)
描述: LED具有高亮度、功率低、密封性好、寿命长、100%防水等特点。
LED数量: 24 电压: 24V

3C认证产品
4" Tail lamp
Type Number: NG09158
Description: LED has high brightness, low power, good sealing and long life, 100% waterproof.
LED quantity: 24 Voltage: 24V
3C Authentication



NG09159



4寸LED后雾灯

型号: NG09159(后雾)
描述: LED具有高亮度、功率低、密封性好、寿命长、100%防水等特点。
LED数量: 24 电压: 24V

3C认证产品
4" Tail lamp
Type Number: NG09159
Description: LED has high brightness, low power, good sealing and long life, 100% waterproof.
LED quantity: 24 Voltage: 24V
3C Authentication



NG09161



6寸LED制动/后位灯

型号: NG09161(制动/后位)
描述: LED具有高亮度、功率低、密封性好、寿命长、100%防水等特点。
LED数量: 24
电压: 24V

3C认证产品
6" Tail Lamps
Type Number:NG09161
Description: LED has high brightness, low power, good sealing and long life 100% waterproof.
LED quantity:24 Voltage:24V
3C Authentication



NG09162

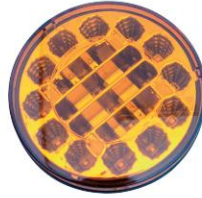

6寸LED转向灯

型号: NG09162(转向)
描述: LED具有高亮度、功率低、密封性好、寿命长、100%防水等特点。
LED数量: 24
电压: 24V
3C认证产品
6" Tail Lamps
Type Number:NG09162
Description: LED has high brightness, low power,good sealing and long life 100% waterproof.
LED quantity:24 Voltage:24V
3C Authentication



NG09163



6寸LED倒车灯

型号: NG09163(倒车)
描述: LED具有高亮度、功率低、密封性好、寿命长、100%防水等特点。
LED数量: 24
电压: 24V
3C认证产品
6" Tail Lamps
Type Number:NG09163
Description: LED has high brightness, low power,good sealing and long life 100% waterproof.
LED quantity:24 Voltage:24V
3C Authentication



NG09171



4寸LED制动/后位灯

型号: NG09171(制动/后位)
描述: LED具有高亮度、功率低、密封性好、寿命长、100%防水等特点。
LED数量: 24 电压: 24V
3C认证产品
4" Tail lamp
Type Number: NG09160
Description: LED has high brightness, low power,good sealing and long life, 100% waterproof.
LED quantity: 24 Voltage: 24V
3C Authentication



NG09172



4寸LED转向灯

型号: NG09172(转向)
描述: LED具有高亮度、功率低、密封性好、寿命长、100%防水等特点。
LED数量: 24 电压: 24V
3C认证产品
4" Tail lamp
Type Number: NG09161
Description: LED has high brightness, low power,good sealing and long life, 100% waterproof.
LED quantity: 24 Voltage: 24V
3C Authentication



NG09173



4寸LED倒车灯

型号: NG09173(倒车)
描述: LED具有高亮度、功率低、密封性好、寿命长、100%防水等特点。
LED数量: 24 电压: 24V
3C认证产品
4" Tail lamp
Type Number: NG09162
Description: LED has high brightness, low power,good sealing and long life, 100% waterproof.
LED quantity: 24 Voltage: 24V
3C Authentication



NG09174



4寸LED后雾灯

型号: NG09174(后雾)
描述: LED具有高亮度、功率低、密封性好、寿命长、100%防水等特点。
LED数量: 24 电压: 24V
3C认证产品
4" Tail lamp
Type Number: NG09163
Description: LED has high brightness, low power,good sealing and long life, 100% waterproof.
LED quantity: 24 Voltage: 24V
3C Authentication



NG09175 NG09176



4寸LED圆灯 (灌胶密封)

型号: NG09175 (制动/后位)
NG09176 (转向)
NG09177 (倒车)
NG09178 (后雾)
性能: LED具有高亮度、功率低、灌胶密封、寿命长、100%防水性等特点。
LED数量: 18 电压: 24V
3C认证产品
LED quantity: 18
Voltage: 24V
3C Authentication



NG09312 NG09313



4寸LED圆灯

型号: NG09312 (制动/后位)
NG09313 (转向)
NG09314 (倒车)
NG09315 (后雾)
性能: LED具有高亮度、功率低、密封性好、寿命长、100%防水性等特点。
LED数量: 18 电压: 24V
3C认证产品
LED quantity: 18
Voltage: 24V
3C Authentication



NG09311

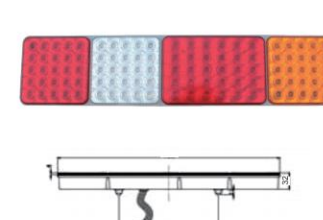

后组合灯LED

型号: NG09311
描述: 适用于轿车, 转向灯、倒车灯、后雾灯、制动/后位灯。
LED具有高亮度、功率低、密封性好、寿命长, 100%防水性的特点。
LED数量: 105 电压: 24V
Tail Lamp LED
Type Number:NG09311
Description:With the functions of the Turn lamp,Backup lamp.stop&Rear position lamp.
LED has high brightness,low power, good sealing and long life, 100% waterproof.
LED quantity:105
Voltage:24V

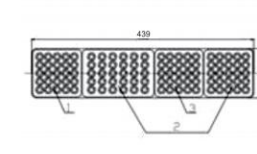

NG09204



型号: NG09204
用途: LED汽车前示廓灯
LED数量: 6 电压: 24V
3C认证产品
Tail Lamps
Type Number:NG09204
Application: LED Front Clearance lamp
LED quantity:6 Voltage:24V
3C Authentication

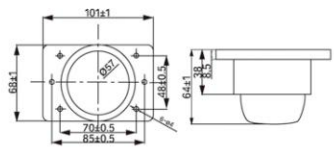

NG09205



型号: NG09205
用途: LED汽车后示廓灯
LED数量: 6 电压: 24V
3C认证产品
Tail Lamps
Type Number:NG09205
Application: LED Rear Clearance lamp
LED quantity:6 Voltage:24V
3C Authentication

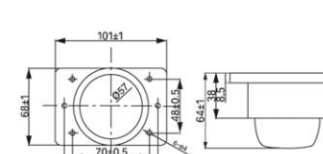

NG09206



LED侧标志灯

型号: NG09206
用途: 用于车辆侧面, 表明车辆向左或向右的灯具, LED具有高亮度、功率低、密封性好、寿命长, 100%防水等特点。
LED数量: 6/6 电压: 24V
3C认证产品
Tail Lamps
Type Number:NG09206
Application: LED has high brightness, low power,good sealing and long life, 100% waterproof.
LED quantity:6/6 Voltage:24V
3C Authentication

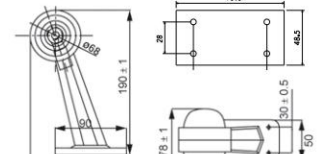

NG09208



LED侧标志灯

型号: NG09208
用途: LED具有高亮度、功率低、密封性好、寿命长、100%防水性的特点。
电压: 24V/12V/9-30V
Side lamp LED
Type Number:NG09208
Description: LED has high brightness, low power,good sealing and long life, 100% waterproof.
Voltage: 24V/12V/9-30V

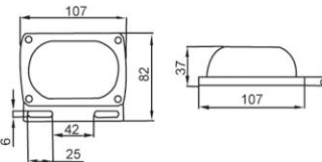

NG09209

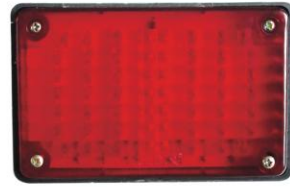

LED后雾灯

型号: NG09209
用途: LED具有高亮度、功率低、密封性好、寿命长、100%防水性的特点。
LED数量: 56
电压: 24V/12V
Rear Fog lamp LED
Type Number:NG09209
Description: LED has high brightness, low power,good sealing and long life, 100% waterproof.
LED quantity: 56
Voltage: 24V/12V

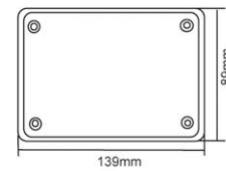

NG09220

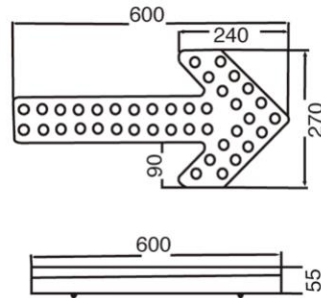
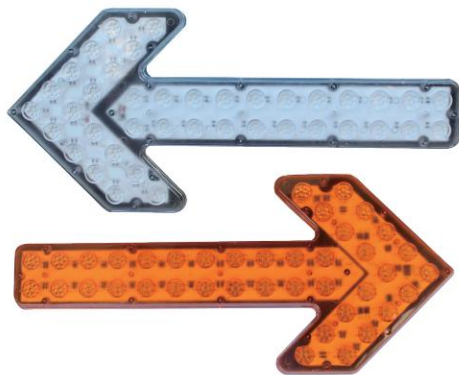

LED箭头指示灯(黄/白)

型号: NG09220
描述: LED具有超高亮度, 功率低、密封性好、寿命长、100%防水的特点用于道路清扫车、洒水车、道路方向指示等。
LED数量: 640 电压: 12/24V
Arrow Lamp LED
Type Number:NG09220
Description:with the functions of stop lamp,Rear position lamp and turn lamp,640PCS super bright Flux LED With UV polycarbonate lens for enhanced chemical resistance 100% waterproof.
LED quantity:36/36/36
Voltage:24V/12V/9-30V

NG09220-1

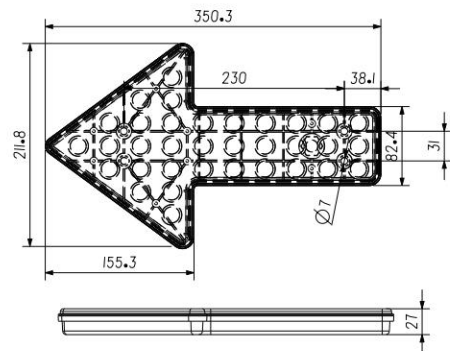
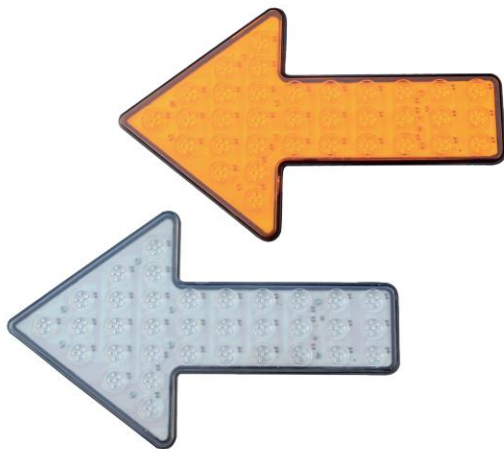

LED箭头指示灯(黄/白)

型号: NG09220-1
描述: LED具有超高亮度, 功率低、密封性好、寿命长、100%防水的特点用于道路清扫车、洒水车、道路方向指示等。
LED数量: 204 电压: 12/24V
Arrow Lamp LED
Type Number:NG09220-1
Description:with the functions of stop lamp,Rear position lamp and turn lamp,204PCS super bright Flux LED With UV polycarbonate lens for enhanced chemical resistance 100% waterproof.
LED quantity:36/36/36
Voltage:24V/12V/9-30V

NG09230



LED汽车前示廓灯

型号: NG09230
LED数量: 6
电压: 24V
3C认证产品
Front Outline Marker lamp
Type Number:NG09230
LED quantity: 6
Voltage:24V
3C Authentication

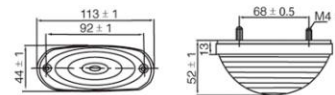

NG09231



LED汽车后示廓灯

型号: NG09231
LED数量: 6
电压: 24V
3C认证产品
Rear Outline Marker lamp
Type Number:NG09231
LED quantity: 6
Voltage:24V
3C Authentication

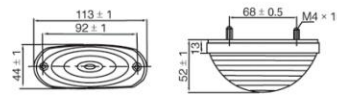

NG09212



后尾灯LED

型号: NG09212
用途: 具有后位灯、制动灯、转向灯的功能。LED具有高亮度、功率低、密封性好、寿命长、100%防水性的特点。
LED数量: 36/36
电压: 24V/12V
Tail lamp
Type Number:NG09212
Description: LED has high brightness, low power,good sealing and long life, 100% waterproof.
LED quantity: 36/36
Voltage: 24V/12V

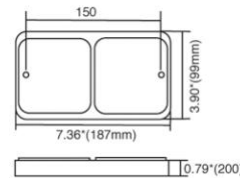

NG09213



后组合灯LED

型号: NG09213
用途: 具有制动/后位, 转向灯的功能。采用75颗LED,具有超高亮、强耐化学性, 100%防水性的特点。
LED数量: 24/24/24
电压: 24V/12V/9-30V
E-mark 认证产品
Tail lamp LED
Type Number:NG09213
Description: With the functions of stop lamp,rear position lamp and turn lamp. 72 pcs super bright Flux LED with UV Polycarbonate lens for enhanced chemical resistance 100% waterproof.
LED quantity: 24/24/24
Voltage:24V/12V/9-30V
E-mark Authentication

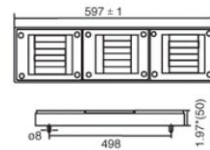

NG09214



后组合灯LED

型号: NG09214
用途: 具有制动/后位、转向灯、后回反复射器的功能。采用108颗LED,具有超高亮、强耐化学性, 100%防水性的特点。
LED数量: 36/36/36
电压: 24V/12V/9-30V
Tail lamp LED
Type Number:NG09214
Description: With the functions of stop lamp,rear position lamp and turn lamp. 108 pcs super bright Flux LED with UV Polycarbonate lens for enhanced chemical resistance 100% waterproof.
LED quantity:36/36/36
Voltage:24V/12V/9-30V

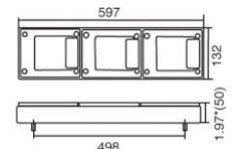

NG09215



后组合灯LED

型号: NG09215
用途: 具有制动/后位、转向灯的功能。采用48颗LED,具有超高亮、强耐化学性, 100%防水性的特点。
LED数量: 24/24
电压: 24V/12V/9-30V
E-mark 认证产品
Tail lamp LED
Type Number:NG09215
Description: With the functions of stop lamp,rear position lamp and turn lamp. 48 pcs super bright Flux LED with UV Polycarbonate lens for enhanced chemical resistance 100% waterproof.
LED quantity:24/24
Voltage:24V/12V/9-30V
E-mark Authentication

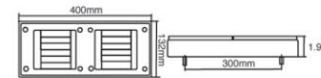

NG09216

后组合灯LED



型号: NG09216
用途: 具有制动/后位、转向灯、后回
复反射器的功能。采用72颗LED,具有
超高亮、强耐化学性,100%防水性的
特点。
LED数量: 36/36
电压: 24V/12V/9-30V
Tail lamp LED
Type Number:NG09216
Description: With the functions of stop
lamp, rear position lamp and turn lamp.
72 pcs super bright Flux LED with UV
Polycarbonate lens for enhanced
chemical resistance 100% waterproof.
LED quantity:36/36
Voltage:24V/12V/9-30V

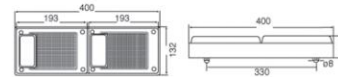

NG09217

后组合灯LED(灯泡式)



型号: NG09217
用途: 具有制动/后位、转向灯、牌照灯
的功能。功率更低、寿命更长、散热性
好。
Tail lamp
Type Number:NG09217
Description:Power and lower, longer
service life, good heat dissipation.

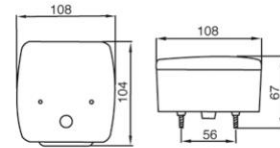

NG09218

标志灯



型号: NG09218
用途: 采用2颗LED,具有超高亮、
强耐化学性,100%防水性的特点。
LED数量: 2
E-mark 认证产品
电压: 24V/12V/9-30V
Marking Lamps LED
Type Number:NG09218
Description: 2 pcs super bright Flux
LED with UV Polycarbonate lens for
enhanced chemical resistance 100%
waterproof.
LED quantity:2
Voltage:24V/12V/9-30V
E-mark Authentication

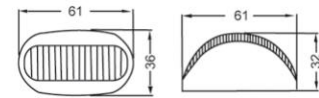

NG09219

ABS报警灯



型号: NG09219
ABS Warning Lamp
Type Number: NG09219

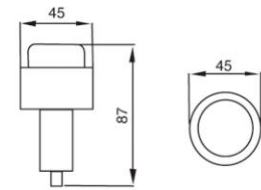

NG09221

LED后尾灯

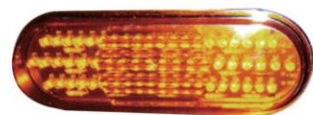

型号: NG09221 (原NG09221-1)
用途: LED具有高亮度、功率低、
密封性好、寿命长,100%防水性的
特点。
LED数量: 45
电压: 12V/24V
Tail Lamp LED
Type Number:NG09221
Application:LED has high brightness,
low power, good sealing and long life,
100% waterproof.
LED quantity:45
Voltage:12V/24V

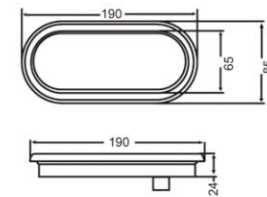

NG09223

LED后尾灯



型号: NG09223 (原NG09223-2)
用途: LED具有高亮度、功率低、
密封性好、寿命长,100%防水性的
特点。
LED数量: 60
电压: 12V/24V
Tail Lamp LED
Type Number:NG09223
Application:LED has high brightness,
low power, good sealing and long life,
100% waterproof.
LED quantity:60
Voltage:12V/24V

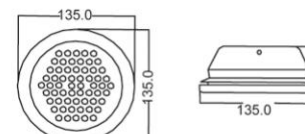

NG09224

LED后尾灯



型号: NG09224
用途: LED具有高亮度、功率低、
密封性好、寿命长,100%防水性的
特点。
LED数量: 13
电压: 12V/24V/9-30V
Tail Lamp LED
Type Number:NG09224
Application:LED has high brightness,
low power, good sealing and long life,
100% waterproof.
LED quantity:13
Voltage:12V/24V/9-30V

NG09225

LED后尾灯



型号: NG09225 (原NG09225-2)
用途: LED具有高亮度、功率低、
密封性好、寿命长,100%防水性的
特点。
LED数量: 12
电压: 24V/12V/9-30V
Tail Lamp LED
Type Number:NG09225
Application:LED has high brightness,
low power, good sealing and long life,
100% waterproof.
LED quantity:12
Voltage:24V/12V/9-30V

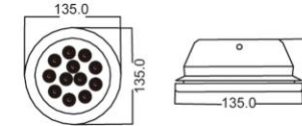

NG09225-1

LED后尾灯



型号: NG09225-1
用途: LED具有高亮度、功率低、
密封性好、寿命长,100%防水性的
特点。
LED数量: 12
电压: 24V/12V/9-30V
Tail Lamp LED
Type Number:NG09225
Application:LED has high brightness,
low power, good sealing and long life,
100% waterproof.
LED quantity:12
Voltage:24V/12V/9-30V

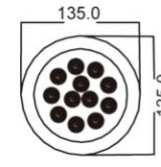

NG09226

后组合灯



型号: NG09226
用途: 具有倒车/转向/后位/制动的
功能
灯泡型号: P21/5W(24V21/5W)
Tail Lamps
Type Number:NG09226
Application:With the functions of Trun
lamp Rear position lamp and Backup
lamp.
Bulb Mode:P21/5W(24V21/5W)

NG09226-1

6寸椭圆灯(泡式)



型号: NG09226-1
用途: 侧转向灯、侧标志灯、
侧反射器
6" Ellipse Lamp
Type Number:NG09226-1
Application:With the functions of side
Turn lamp, side signal lamp and side
reflector.

NG09227-1

后组合灯LED

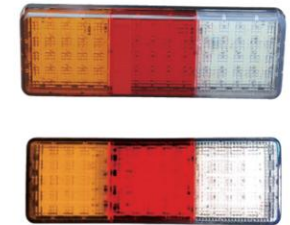

型号: NG09227-1
用途: 具有制动、后位、倒车、转向
灯的功能。LED具有高亮度、功率低、
密封性好、寿命长、100%防水性的
特点。
LED数量: 25/25/25
电压: 12/24V/9-30V
E-mark/3C认证产品
Tail Lamp LED
Description:With the functions of stop
lamp,Rear position lamp and turn
lamp.LED has brightness,Low power,
good sealing and long life
100% waterproof.
LED quantity: 25/25/25
Voltage: 12/24V/9-30V
E-mark /3CAuthentication

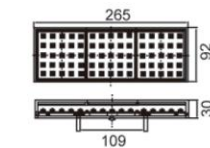

NG09227-2



后组合灯LED

型号: NG09227-2
用途: 具有制动、后位、后雾、转向灯的功能。LED具有高亮度、功率低、密封性好、寿命长、100%防水性的特点。
LED数量: 25/25/25
电压: 12/24V/9-30V
E-mark认证产品
Tail Lamp LED
Description:With the functions of stop lamp,Rear position lamp and turn lamp.LED has brightness,Low power, good sealing and long life
100% waterproof.
LED quantity: 25/25/25
Voltage: 12/24V/9-30V
E-mark Authentication

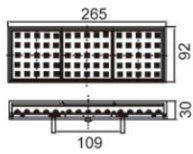

NG09227-3

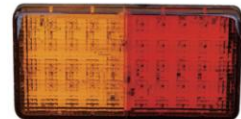

后组合灯LED

型号: NG09227-3
用途: 具有制动、后位、转向灯的功能。LED具有高亮度、功率低、密封性好、寿命长、100%防水性的特点。
LED数量: 25/25
电压: 12/24V/9-30V
E-mark认证产品
Tail Lamp LED
Description:With the functions of stop lamp,Rear position lamp and turn lamp.LED has brightness,Low power, good sealing and long life
100% waterproof.
LED quantity: 25/25
Voltage: 12/24V/9-30V
E-mark Authentication

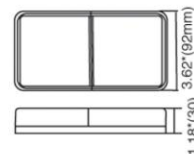
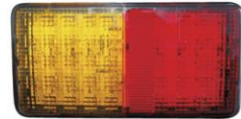

NG09227-4

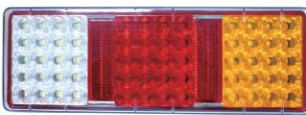

后组合灯LED

型号: NG09227-4
用途: 具有制动、后位、后雾、转向灯的功能。LED具有高亮度、功率低、密封性好、寿命长、100%防水性的特点。
LED数量: 20/20/20
电压: 12/24V/9-30V
E-mark认证产品
Tail Lamp LED
Description:With the functions of stop lamp,Rear position lamp and turn lamp.LED has brightness,Low power, good sealing and long life
100% waterproof.
LED quantity: 20/20/20
Voltage: 12/24V/9-30V
E-mark Authentication

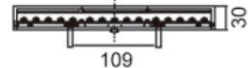
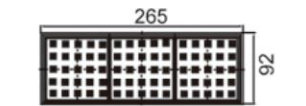

NG09227-5

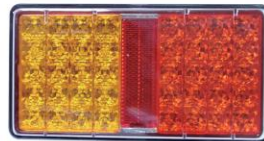

后组合灯LED

型号: NG09227-5
用途: 具有制动、后位、转向灯的功能。LED具有高亮度、功率低、密封性好、寿命长、100%防水性的特点。
LED数量: 20/20
电压: 12/24V/9-30V
E-mark认证产品
Tail Lamp LED
Description:With the functions of stop lamp,Rear position lamp and turn lamp.LED has brightness,Low power, good sealing and long life
100% waterproof.
LED quantity: 20/20
Voltage: 12/24V/9-30V
E-mark Authentication

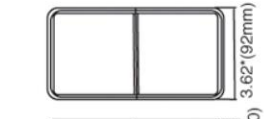

NG09228



双面灯

型号: NG09228 (原NG02020-1)
用途: LED具有高亮度、功率低、密封性好、寿命长、100%防水性的特点。
LED数量: 6/6
电压: 12/24V/9-30V
Double Face LED
Type Number:NG09228
Description:LED has brightness,Low power,good sealing and long life
100% waterproof.
LED quantity: 6/6
Voltage: 12/24V/9-30V

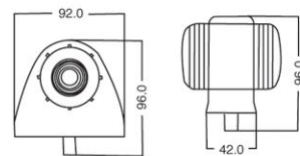

NG09233



LED后尾灯

型号: NG09233
描述: LED具有高亮度、功率低、密封性好、寿命长、100%防水性。
LED数量: 12/18
电压: 12/24V/9-30V
E-mark认证产品
Tail Lamp LED
Type Number: NG09233
Description:LED has brightness, Low power,good sealing and long life
100% waterproof.
LED quantity: 12/18
Voltage: 12/24V/9-30V
E-mark Authentication

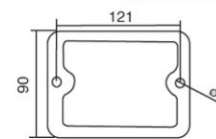

NG09233-1



LED后尾灯

型号: NG09233-1
描述: LED具有高亮度、功率低、密封性好、寿命长、100%防水性。
LED数量: 5/5
电压: 12/24V/9-30V
E-mark认证产品
Tail Lamp LED
Type Number: NG09233-1
Description:LED has brightness, Low power,good sealing and long life
100% waterproof.
LED quantity: 5/5
Voltage: 12/24V/9-30V
E-mark Authentication

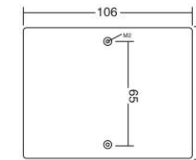

NG09301



后组合灯LED

型号: NG09301
描述: 转向灯、倒车灯、后雾灯、制动/后位灯(带爆闪)、牌照灯。LED具有高亮度、功率低、密封性好、寿命长、100%防水性的特点。
LED数量: 115/109
电压: 24V/12V
Tail Lamp LED
Type Number:NG09301
Description:With the functions of the Turn lamp,Backup lamp,stop&Rear position lamp(flash explosion).
LED has high brightness,low power, good sealing and long life,
100% waterproof.
LED quantity:115/109
Voltage:12V/24V

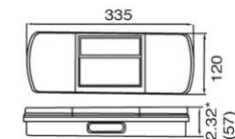

NG09302



后组合灯LED

型号: NG09302
描述: 转向灯、倒车灯、后雾灯、制动/后位灯(带爆闪)、牌照灯。LED具有高亮度、功率低、密封性好、寿命长、100%防水性的特点。
LED数量: 144/150
电压: 24V/12V
Tail Lamp LED
Type Number:NG09302
Description:With the functions of the Turn lamp,Backup lamp,stop&Rear position lamp(flash explosion).
LED has high brightness,low power, good sealing and long life,
100% waterproof.
LED quantity:144/150
Voltage:24V/12V

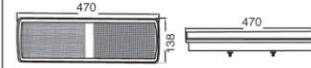

NG09303



后组合灯LED

型号: NG09303
描述: 转向灯、倒车灯、后雾灯、制动/后位灯(带爆闪)、牌照灯。LED具有高亮度、功率低、密封性好、寿命长、100%防水性的特点。
LED数量: 144/150
电压: 24V/12V
Tail Lamp LED
Type Number:NG09303
Description:With the functions of the Turn lamp,Backup lamp,stop&Rear position lamp(flash explosion).
LED has high brightness,low power, good sealing and long life,
100% waterproof.
LED quantity:144/150
Voltage:24V/12V

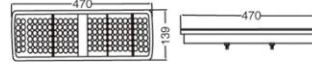

NG09304



LED后尾灯

型号: NG09304
描述: 转向灯、倒车灯、后雾灯、制动/后位灯。LED具有高亮度、功率低、密封性好、寿命长、100%防水性的特点。
LED数量: 96
电压: 24V/12V
Tail Lamp LED
Type Number:NG09304
Description:With the functions of the Turn lamp,Backup lamp,stop&Rear position lamp.LED has high brightness,low power,good sealing and long life,100% waterproof.
LED quantity:96
Voltage:24V/12V

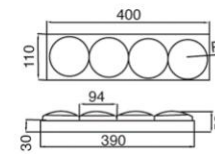

NG09305



后组合灯LED

型号: NG09305
描述: 转向灯、倒车灯、后雾灯、制动/后位灯。LED具有高亮度、功率低、密封性好、寿命长、100%防水性的特点。
LED数量: 120
电压: 24V/12V
Tail Lamp LED
Type Number:NG09305
Description:With the functions of the Turn lamp,Backup lamp,stop&Rear position lamp.LED has high brightness,low power,good sealing and long life,100% waterproof.
LED quantity:120
Voltage:24V/12V

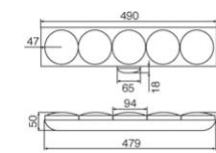

NG09306



后组合灯LED

型号: NG09306
描述: 转向灯、倒车灯、制动/后位灯的功能, LED具有高亮度、功率低、密封性好、寿命长, 100%防水性的特点。
LED数量: 60 电压: 24V/12V
Tail Lamp LED
Type Number: NG09306
Description: With the functions of the Turn lamp, Backup lamp, stop & Rear position lamp, LED has high brightness, low power, good sealing and long life, 100% waterproof.
LED quantity: 60
Voltage: 24V/12V

NG11001



NG09234

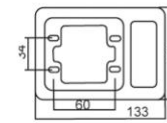

LED后尾灯

型号: NG11001 (由NG09234组成)
描述: LED具有高亮度、功率低、密封性好、寿命长, 100%防水性的特点。
LED数量: 10 电压: 24V
E-mark认证产品
Tail Lamp LED
Type Number: NG11001
Description: LED has high brightness, low power, good sealing and long life, 100% waterproof.
LED quantity: 10
Voltage: 24V
E-mark Authentication

NG11002



NG09235



NG09234

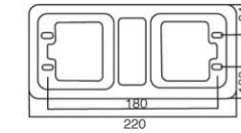

后组合灯LED

型号: NG11002 (由NG09234/235组成)
描述: LED具有高亮度、功率低、密封性好、寿命长, 100%防水性的特点。
LED数量: 10/10 电压: 24V
E-mark认证产品
Tail Lamp LED
Type Number: NG11002
Description: LED has high brightness, low power, good sealing and long life, 100% waterproof.
LED quantity: 10/10
Voltage: 24V
E-mark Authentication

NG11003

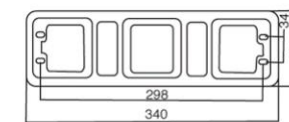

LED后尾灯

型号: NG11003 (由NG09234/235/236组成)
描述: LED具有高亮度、功率低、密封性好、寿命长, 100%防水性的特点。
LED数量: 10/10/10 电压: 24V
E-mark认证产品
Tail Lamp LED
Type Number: NG11003
Description: LED has high brightness, low power, good sealing and long life, 100% waterproof.
LED quantity: 10/10/10
Voltage: 24V
E-mark Authentication

NG11004

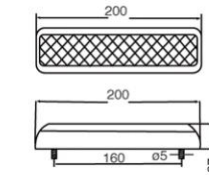

LED侧灯

型号: NG11004 (原NG10003-1)
描述: 采用24颗LED, 具有高亮度、强耐化学性, 100%防水性的特点。
LED数量: 24
电压: 12V/24V
LED Side Lamp
Type Number: NG11004
Description: 24 Pcs Super bright Flux LED with UV Polycarbonate lens for enhanced chemical resistance 100% waterproof.
LED quantity: 24
Voltage: 12V/24V

NG11005(W/R/Y)

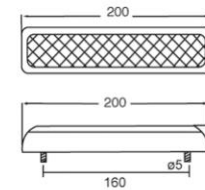

LED后尾灯

型号: NG11005 (W/R/Y)
用途: LED具有高亮度、功率低、密封性好、寿命长, 100%防水性的特点。
LED数量: 6/6
电压: 12/24V
Tail Lamp
Type Number: NG11005 (W/R/Y)
Description: LED has brightness, Low power, good sealing and long life 100% waterproof.
LED quantity: 6/6
Voltage: 12/24V

NG11006

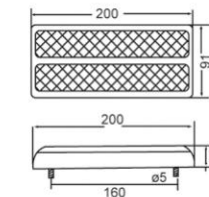

LED后尾灯

型号: NG11006 (原NG10003-3)
描述: LED具有高亮度、功率低、密封性好、寿命长, 100%防水性的特点。
LED数量: 36/36
电压: 12/24V
Tail Lamp LED
Type Number: NG09233
Description: LED has brightness, Low power, good sealing and long life 100% waterproof.
LED quantity: 36/36
Voltage: 12/24V

NG11007

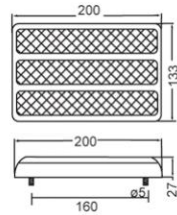

LED后尾灯

型号: NG11007
描述: LED具有高亮度、功率低、密封性好、寿命长, 100%防水性的特点。
LED数量: 36/36/36
电压: 24V/12V
Tail Lamp LED
Type Number:NG11007
Description:LED has high brightness, low power,good sealing and long life, 100% waterproof.
LED quantity: 36/36/36
Voltage:12V/24V

NG11008

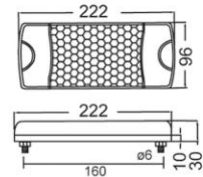

后组合灯LED

型号: NG11008 (原NG01014-1)
描述: LED具有高亮度、功率低、密封性好、寿命长, 100%防水性的特点。
LED数量: 40
电压: 24V/12V/9-30V
Tail Lamp LED
Type Number:NG11008
Description:LED has high brightness, low power,good sealing and long life, 100% waterproof.
LED quantity:40
Voltage:24V/12V/9-30V

NG11009

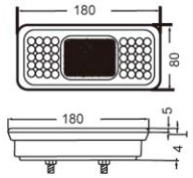

后组合灯LED

型号: NG11009(原NG09221-3)
描述: LED具有高亮度、功率低、密封性好、寿命长, 100%防水性的特点。
LED数量: 20/20
电压: 24V/12V/9-30V
Tail Lamp LED
Type Number:NG11009
Description:LED has high brightness, low power,good sealing and long life, 100% waterproof.
LED quantity:20/20
Voltage:24V/12V/9-30V

NG11010

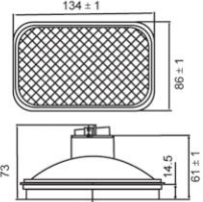
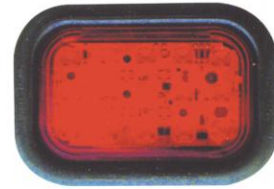

LED后尾灯

型号: NG11010(原NG09223-1)
描述: LED具有高亮度、功率低、密封性好、寿命长, 100%防水性的特点。
电压: 24V
Tail Lamp LED
Type Number:NG11010
Description:LED has high brightness, low power,good sealing and long life, 100% waterproof.
Voltage:24V

NG11011

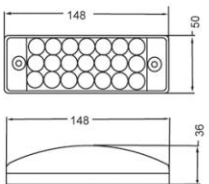

LED后尾灯

型号: NG11011(原NG01011-2)
开孔尺寸: 20.5
描述: LED具有高亮度、功率低、密封性好、寿命长, 100%防水性的特点。
电压: 24V/12V
Tail Lamp LED
Type Number:NG11011
Description:LED has high brightness, low power,good sealing and long life, 100% waterproof.
Voltage:24V/12V

NG11012

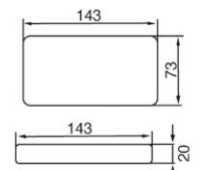

LED后尾灯

型号: NG11012
描述: 具有制动/后位、转向、牌照灯、后回复反射器功能。LED具有高亮度、功率低、密封性好、寿命长, 100%防水性的特点。
LED数量: 20/20/4 电压: 24V/12V
Tail Lamp LED
Type Number:NG11012
Description:LED has high brightness, low power,good sealing and long life, 100% waterproof.
LED quantity:20/20/4
Voltage:24V/12V

NG11013

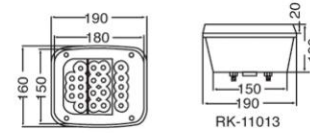

LED后尾灯

型号: NG11013
描述: 具有制动/后位、转向、倒车的功能。LED具有高亮度、功率低、密封性好、寿命长, 100%防水性的特点。
LED数量: 8/8/5 电压: 24V/12V
Tail Lamp LED
Type Number:NG11013
Description:LED has high brightness, low power,good sealing and long life, 100% waterproof.
LED quantity: 8/8/5
Voltage:24V/12V

NG11014

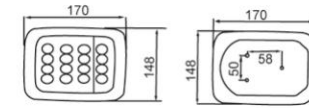

LED后尾灯

型号: NG11014
描述: LED具有高亮度、功率低、密封性好、寿命长, 100%防水性的特点。
LED数量: 12/4 电压: 24V/12V
Tail Lamp LED
Type Number:NG11014
Description:LED has high brightness, low power,good sealing and long life, 100% waterproof.
LED quantity: 12/4
Voltage:24V/12V

NG11015

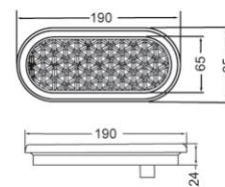

LED后尾灯

型号: NG11015(原NG0926-1)
描述: LED具有高亮度、功率低、密封性好、寿命长, 100%防水性的特点。
LED数量: 10
电压: 12V/24V
Tail Lamp LED
Type Number:NG11015
Description:LED has high brightness, low power,good sealing and long life, 100% waterproof.
LED quantity:10
Voltage:12V/24V

NG11016

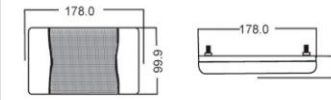

LED后尾灯

型号: NG11016
描述: 转向、后位、制动的功能。LED具有高亮度、功率低、密封性好、寿命长, 100%防水性的特点。
LED数量: 36
电压: 24V
Tail Lamp LED
Type Number:NG11016
Description:LED has high brightness, low power,good sealing and long life, 100% waterproof.
LED quantity:36
Voltage:24V

NG11017



LED后尾灯

型号: NG11017
用途: LED具有高亮度、功率低、密封性好、寿命长、100%防水性的特点。
LED数量: 10
电压: 12/24V/9-30V
Tail Lamp LED
Type Number:NG11017
Description:LED has brightness,Low power,good sealing and long life 100% waterproof.
LED quantity: 10
Voltage: 12/24V

NG11018

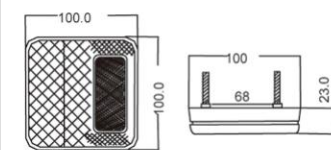

LED后尾灯

型号: NG11018(原NG10004-1)
描述: 制动/后位、转向、后回复反射器的功能, LED具有高亮度、功率低、密封性好、寿命长、100%防水性。
LED数量: 7/7
电压: 12/24V/9-30V
Tail Lamp LED
Type Number: NG11018
Description:LED has brightness, Low power,good sealing and long life 100% waterproof.
LED quantity: 7/7
Voltage: 12/24V/9-30V

NG11019



LED后尾灯(爆闪)

型号: NG11019
描述: LED具有高亮度、功率低、密封性好、寿命长, 100%防水性的特点。
LED数量: 29
电压: 24V/12V
Tail Lamp LED
Type Number:NG11009
Description:LED has high brightness, low power,good sealing and long life, 100% waterproof.
LED quantity: 29
Voltage:12V/24V

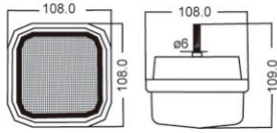

NG11020



LED后尾灯(爆闪)

型号: NG11020
描述: LED具有高亮度、功率低、密封性好、寿命长, 100%防水性的特点。
LED数量: 32
电压: 24V/12V
Tail Lamp LED
Type Number:NG11020
Description:LED has high brightness, low power,good sealing and long life, 100% waterproof.
LED quantity: 32
Voltage:12V/24V

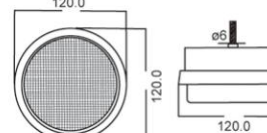

NG11021



LED后尾灯

型号: NG11021
描述: 制动/后位/侧标志/侧回复/后反射器功能, LED具有高亮度、功率低、密封性好、寿命长, 100%防水性的特点。
LED数量: 12/4/4
电压: 12V/24V
Tail Lamp LED
Type Number:NG11021
Description:LED has high brightness, low power,good sealing and long life, 100% waterproof.
LED quantity:12/4/4
Voltage:12V/24V

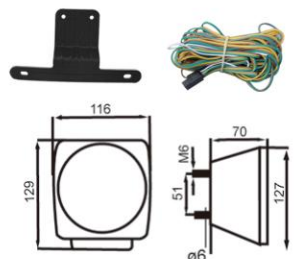

NG11022



LED后尾灯

型号: NG11022
描述: 制动/后位/侧标志/侧回复/后反射器功能, LED具有高亮度、功率低、密封性好、寿命长, 100%防水性的特点。
LED数量: 12/4/4
电压: 12V/24V
Tail Lamp LED
Type Number:NG11022
Description:LED has high brightness, low power,good sealing and long life, 100% waterproof.
LED quantity:12/4/4
Voltage:12V/24V

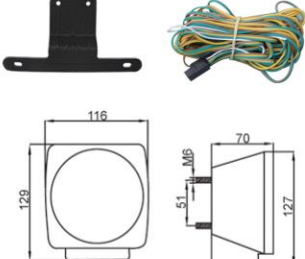

NG11023



LED后尾灯

型号: NG11023
描述: LED具有高亮度、功率低、密封性好、寿命长, 100%防水性的特点。
电压: 12V/24V
Tail Lamp LED
Type Number:NG11023
Description:LED has high brightness, low power,good sealing and long life, 100% waterproof.
Voltage:12V/24V

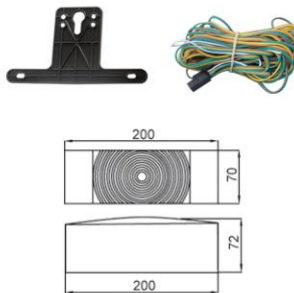

NG11024



LED后尾灯

型号: NG11024
描述: 制LED具有高亮度、功率低、密封性好、寿命长, 100%防水性的特点。
LED数量: 7
电压: 12V/24V
Tail Lamp LED
Type Number:NG11024
Description:LED has high brightness, low power,good sealing and long life, 100% waterproof.
LED quantity:7
Voltage:12V/24V

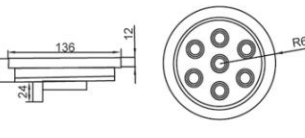

NG11025



LED后尾灯

型号: NG11025
描述: LED具有高亮度、功率低、密封性好、寿命长, 100%防水性的特点。
LED数量: 10
电压: 12V/24V
Tail Lamp LED
Type Number:NG11025
Description:LED has high brightness, low power,good sealing and long life, 100% waterproof.
LED quantity: 10
Voltage:12V/24V

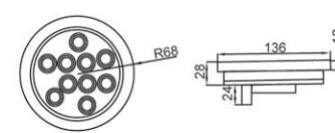

NG11025-1



型号: NG11025-1 (泡式)
Type Number:NG11025-1

NG11026



LED后尾灯

型号: NG11026
描述: LED具有高亮度、功率低、密封性好、寿命长, 100%防水性的特点。
LED数量: 7
电压: 12V/24V
Tail Lamp LED
Type Number:NG11026
Description:LED has high brightness, low power,good sealing and long life, 100% waterproof.
LED quantity:7
Voltage:12V/24V

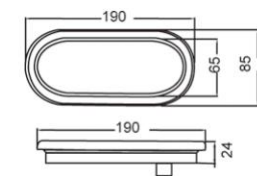

NG11027



LED后尾灯

型号: NG11027
描述: LED具有高亮度、功率低、密封性好、寿命长, 100%防水性的特点。
LED数量: 10
电压: 12V/24V
Tail Lamp LED
Type Number:NG11027
Description:LED has high brightness, low power,good sealing and long life, 100% waterproof.
LED quantity:10
Voltage:12V/24V

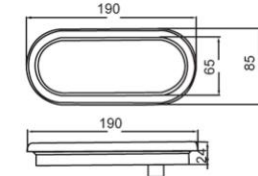

NG11028



后尾灯(灯泡)

型号: NG11028
用途: 具有转向灯/制动灯/后位灯/倒车灯/前后示廓灯/后回复反射器/后雾灯的功能
灯泡型号: P21W(24V21W)
P21/5W(24V21/5W)
Tail Lamp
Type Number:NG11028
Application:With the steering lamp/Ligh/Rear Position lamp/Reversing lamp/Rear end-outline marker lamp/Retro-reflecting device function.
Bulb Mode: P21W(24V21W)
P21/5W(24V21/5W)

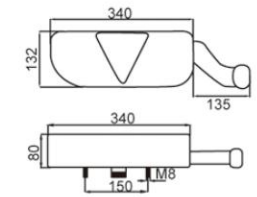

NG11029



后尾灯(灯泡)

型号: NG11029
用途: 具有转向灯/制动灯/后位灯/倒车灯/侧标示/侧回复/后回复反射器/后雾灯的功能
灯泡型号: P21W(24V21W)
P21/5W(24V21/5W)
Tail Lamp
Type Number:NG11029
Application:With the steering lamp/Ligh/Rear Position lamp/Reversing lamp/Side Label/Side back/Retro-reflecting device function.
Bulb Mode: P21W(24V21W)
P21/5W(24V21/5W)

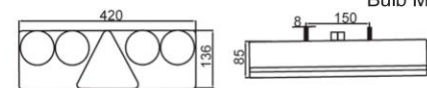

NG11033



后尾灯(灯泡)

型号: NG11033
用途: 具有转向灯/制动灯/后位灯/倒车灯的功能。
灯泡型号: P21W(21V/21W)
P21/5W(21V/21/5W)
Tail Lamp
Type Number: NG11033
Application: With braking lamp/light/ Reversing lamp function.
Bulb Mode: P21W(21V/21W)
P21/5W(21V/21/5W)

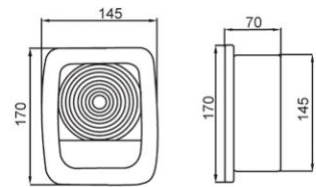

NG11034



后尾灯(灯泡)

型号: NG11034
用途: 具有转向灯/制动灯/后位灯/牌照灯的功能。
灯泡型号: P21W(21V/21W)
P21/5W(21V/21/5W)
Tail Lamp
Type Number: NG11034
Application: With the steering lamp/light/ Rear position lamp/license plate lamp function.
Bulb Mode: P21W(21V/21W)
P21/5W(21V/21/5W)



NG11036



后尾灯(灯泡)

型号: NG11036
灯泡型号: P21W(21V/21W)
P21/5W(21V/21/5W)
Tail Lamp
Type Number: NG11036
Bulb Mode: P21W(21V/21W)
P21/5W(21V/21/5W)

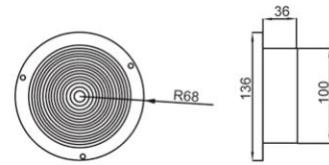

NG11037



后尾灯(灯泡)

型号: NG11037
用途: 具有制动灯/后位灯/牌照灯的功能。
灯泡型号: P21W(21V/21W)
P21/5W(21V/21/5W)
Tail Lamp
Type Number: NG11037
Application: With the light/Rear position lamp/license plate lamp function.
Bulb Mode: P21W(21V/21W)
P21/5W(21V/21/5W)

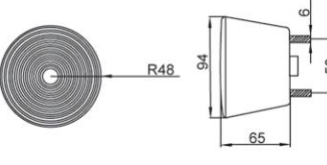

NG11038



后尾灯(灯泡)

型号: NG11038
用途: 具有制动灯/后位灯/侧标志灯/侧回复/后回复反射器的功能。
灯泡型号: P21W(21V/21W)
P21/5W(21V/21/5W)
Tail Lamp
Type Number: NG11038
Application: Having a brake/rear, side marker, side, rear - reflecting devices function.
Bulb Mode: P21W(21V/21W)
P21/5W(21V/21/5W)

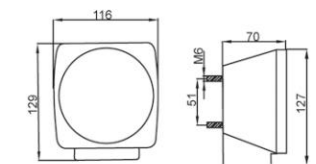

NG11039



后尾灯(灯泡)

型号: NG11039
用途: 具有制动灯/后位灯/侧标志灯/侧回复/后回复反射器的功能。
灯泡型号: P21W(21V/21W)
P21/5W(21V/21/5W)
Tail Lamp
Type Number: NG11039
Application: Having a brake/rear, side marker, side, rear retro-reflecting devices function.
Bulb Mode: P21W(21V/21W)
P21/5W(21V/21/5W)

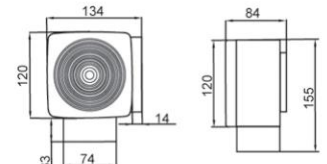

NG11040



后尾灯(灯泡)

型号: NG11040
用途: 具有制动灯/后位灯/转向灯/倒车灯/后回复反射器的功能。
灯泡型号: P21W(21V/21W)
P21/5W(21V/21/5W)
Tail Lamp
Type Number: NG11040
Application: Having a brake/rear, Position, Steering/reflecting, retro-devices function.
Bulb Mode: P21W(21V/21W)
P21/5W(21V/21/5W)

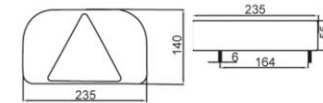

NG11041



后尾灯(灯泡)

型号: NG11041
用途: 具有制动灯/后位灯/转向灯/倒车灯/后雾灯/后回复反射器的功能。
灯泡型号: P21W(21V/21W)
P21/5W(21V/21/5W)
Tail Lamp
Type Number: NG11041
Application: Having a brake/rear, Position, Steering/reflecting, retro-devices function.
Bulb Mode: P21W(21V/21W)
P21/5W(21V/21/5W)

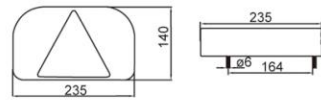

NG11042



后尾灯(灯泡)

型号: NG11042
用途: 具有制动灯/后位灯/转向灯/倒车灯/后雾灯/后回复反射器的功能。
灯泡型号: P21W(21V/21W)
P21/5W(21V/21/5W)
Tail Lamp
Type Number: NG11042
Application: Having a brake/rear, Position, Steering/reflecting, retro-devices function.
Bulb Mode: P21W(21V/21W)
P21/5W(21V/21/5W)

NG11043



后尾灯(灯泡)

型号: NG11043
用途: 具有制动灯/后位灯/转向灯/倒车灯/后雾灯/后示廓灯/后回复反射器的功能。
灯泡型号: P21W(21V/21W)
P21/5W(21V/21/5W)
Tail Lamp
Type Number: NG11043
Application: Having a brake/rear, Position, Steering/reflecting, front an rearedng-outline marker/retro-reflecting devices function.
Bulb Mode: P21W(21V/21W)
P21/5W(21V/21/5W)

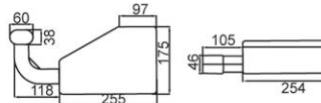

NG11044



示廓灯LED

型号: NG11044
描述: 采用6颗LED, 具有高亮度、超高亮度、强耐化学性, 100%防水性的特点。
LED数量: 6
电压: 24V
Tail Lamp LED
Type Number: NG11044
Description: 6 pcs super bright LED with UV Polycarbonate lens for enhanced chemical Resistance 100% waterproof.
LED quantity: 6
Voltage: 24V

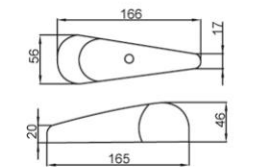

NG11045 L/R



LED后尾灯

型号: NG11045 L/R
描述: 转向灯/后位灯/制动灯/后回复反射器的功能。LED具有高亮度、功率低、密封性好、寿命长, 100%防水性的特点。
LED数量: 5/5
电压: 12V/24V/10-30V
E-mark认证产品
Tail Lamp LED
Type Number: NG11045 L/R
Description: LED has high brightness, low power, good sealing and long life, 100% waterproof.
LED quantity: 5/5
Voltage: 12V/24V/10-30V
E-mark Authentication

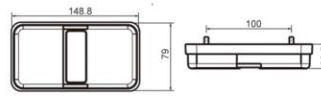

NG11046 L/R



LED后尾灯

型号: NG11046 L/R
描述: 转向灯/后位灯/制动灯/后回复反射器的功能。LED具有高亮度、功率低、密封性好、寿命长, 100%防水性的特点。

LED数量: 10/10
电压: 12V/24V/10-30V

E-mark认证产品

Tail Lamp LED

Type Number:NG11046 L/R

Description:LED has high brightness, low power,good sealing and long life, 100% waterproof.

LED quantity:10/10

Voltage:12V/24V/10-30V

E-mark Authentication

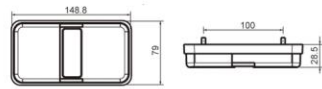

NG11047 L/R



LED后尾灯

型号: NG11047 L/R
描述: 转向灯/后位灯/制动灯/后回复反射器的功能。LED具有高亮度、功率低、密封性好、寿命长, 100%防水性的特点。

LED数量: 5/5
电压: 12V/24V/10-30V

E-mark认证产品

Tail Lamp LED

Type Number:NG11047 L/R

Description:LED has high brightness, low power,good sealing and long life, 100% waterproof.

LED quantity:5/5

Voltage:12V/24V/10-30V

E-mark Authentication

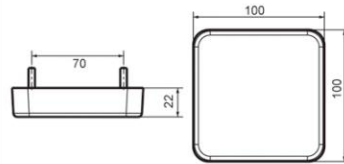

NG11047-1 L/R

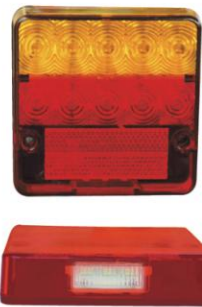

LED后尾灯

型号: NG11047-1 L/R
描述: 转向灯/后位灯/制动灯/牌照灯、后回复反射器的功能。LED具有高亮度、功率低、密封性好、寿命长, 100%防水性的特点。

LED数量: 5/5
电压: 12V/24V/10-30V

E-mark认证产品

Tail Lamp LED

Type Number:NG11047-1 L/R

Description:LED has high brightness, low power,good sealing and long life, 100% waterproof.

LED quantity:5/5

Voltage:12V/24V/10-30V

E-mark Authentication

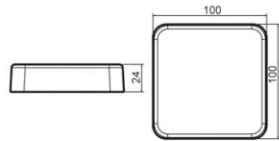

NG11048 L/R



LED后尾灯

型号: NG11048 L/R
描述: 转向灯/后位灯/制动灯/后回复反射器的功能。LED具有高亮度、功率低、密封性好、寿命长, 100%防水性的特点。

LED数量: 6/6
电压: 12V/24V/10-30V

E-mark认证产品

Tail Lamp LED

Type Number:NG11048 L/R

Description:LED has high brightness, low power,good sealing and long life, 100% waterproof.

LED quantity:6/6

Voltage:12V/24V/10-30V

E-mark Authentication

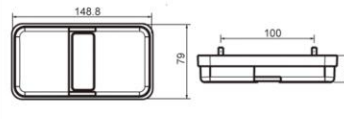

NG11049 L/R



LED后尾灯

型号: NG11049 L/R
描述: 转向灯/后位灯/制动灯/牌照灯/后回复反射器的功能。LED具有高亮度、功率低、密封性好、寿命长, 100%防水性的特点。

LED数量: 8/8/4
电压: 12V/24V/10-30V

E-mark认证产品

Tail Lamp LED

Type Number:NG11049 L/R

Description:LED has high brightness, low power,good sealing and long life, 100% waterproof.

LED quantity:8/8/4

Voltage:12V/24V/10-30V

E-mark Authentication

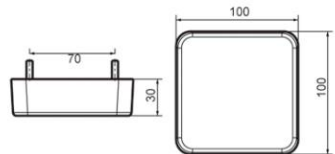

NG11050

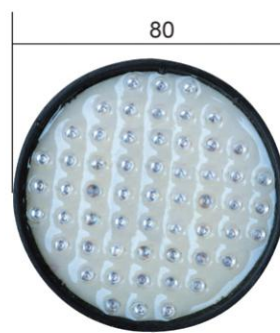

LED后尾灯

型号: NG11050
描述: 后位灯/制动灯功能。LED具有高亮度、功率低、密封性好、寿命长, 100%防水性的特点。

LED数量: 57
电压: 12V/24V

Tail Lamp LED

Type Number:NG11050

Description:LED has high brightness, low power,good sealing and long life, 100% waterproof.

LED quantity:57

Voltage:12V/24V

NG11051



后尾灯(灯泡)

型号: NG11051
用途: 具有制动灯/后位灯/转向灯后雾灯/倒车灯/侧标志灯的功能。

Tail Lamp

Type Number:NG11051

Application:Have brake lamp/rear light/turn on lamp The function of the following fog lamp/headlamp/side marker lamp.

NG11052



LED后尾灯

型号: NG11052
描述: 后位灯/制动灯/转向灯/牌照灯、后回复反射器的功能。LED具有高亮度、功率低、密封性好、寿命长, 100%防水性的特点。

LED数量: 5/5
电压: 12V/24V/9-30V

E-mark认证产品

Tail Lamp LED

Type Number:NG11052

Description:LED has high brightness, low power,good sealing and long life, 100% waterproof.

LED quantity:5/5

Voltage:12V/24V/9-30V

E-mark Authentication

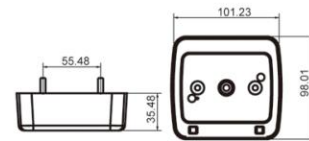

NG12001



LED侧标志灯(1寸)

型号: NG12001
描述: LED具有高亮度、功率低、密封性好、寿命长、100%防水性的特点。

LED数量: 3
电压: 12V/24V

1" Side Lamp LED

Type Number:NG12001

Description:LED has high brightness, low power,good sealing and long life, 100% waterproof.

LED quantity:3

Voltage:12V/24V

NG12002



LED侧标志灯(1.5寸)

型号: NG12002
描述: LED具有高亮度、功率低、密封性好、寿命长、100%防水性的特点。

LED数量: 5
电压: 12V/24V

1.5" Side Lamp LED

Type Number:NG12002

Description:LED has high brightness, low power,good sealing and long life, 100% waterproof.

LED quantity:5

Voltage:12V/24V

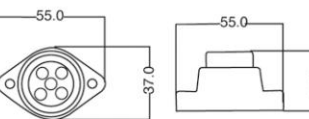

NG12003



LED侧标志灯(2寸)

型号: NG12003
描述: LED具有高亮度、功率低、密封性好、寿命长、100%防水性的特点。

LED数量: 6
电压: 12V/24V

2" Side Lamp LED

Type Number:NG12003

Description:LED has high brightness, low power,good sealing and long life, 100% waterproof.

LED quantity:6

Voltage:12V/24V

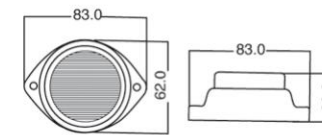

NG12004



LED侧标志灯(2.5寸)

型号: NG12004
描述: LED具有高亮度、功率低、密封性好、寿命长、100%防水性的特点。

LED数量: 7
电压: 12V/24V

2.5" Side Lamp LED

Type Number:NG12004

Description:LED has high brightness, low power,good sealing and long life, 100% waterproof.

LED quantity:7

Voltage:12V/24V

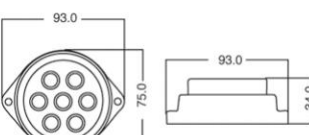

NG12004-1



LED侧标志灯(2.5寸)

型号: NG12004-1
描述: LED具有高亮度、功率低、密封性好、寿命长、100%防水性的特点。
LED数量: 6
电压: 12V/24V
2.5" Side Lamp LED
Type Number: NG12004-1
Description: LED has high brightness, low power, good sealing and long life, 100% waterproof.
LED quantity: 6
Voltage: 12V/24V

NG12005

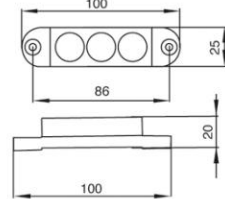

LED侧标志灯

型号: NG12005
描述: LED具有高亮度、功率低、密封性好、寿命长、100%防水性的特点。
LED数量: 3
电压: 12V/24V
Side Lamp LED
Type Number: NG12005
Description: LED has high brightness, low power, good sealing and long life, 100% waterproof.
LED quantity: 3
Voltage: 12V/24V

NG12006

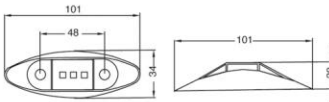

LED侧标志灯

型号: NG12006(原NG09230-1)
描述: LED具有高亮度、功率低、密封性好、寿命长、100%防水性的特点。
LED数量: 3
电压: 12V/24V
Side Lamp LED
Type Number: NG12006
Description: LED has high brightness, low power, good sealing and long life, 100% waterproof.
LED quantity: 3
Voltage: 12V/24V

NG12007

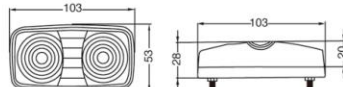

LED侧标志灯

型号: NG12007(原NG07005)
描述: LED具有高亮度、功率低、密封性好、寿命长、100%防水性的特点。
LED数量: 10
电压: 12V/24V/9-30V
Side Lamp LED
Type Number: NG12007
Description: LED has high brightness, low power, good sealing and long life, 100% waterproof.
LED quantity: 10
Voltage: 12V/24V/9-30V

NG12008

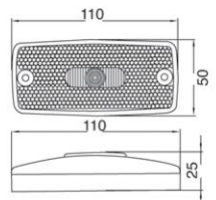

LED侧标志灯

型号: NG12008(原NG02019-1)
描述: LED具有高亮度、功率低、密封性好、寿命长、100%防水性的特点。
LED数量: 3
电压: 12V/24V/9-30V
Side Lamp LED
Type Number: NG12008
Description: LED has high brightness, low power, good sealing and long life, 100% waterproof.
LED quantity: 3
Voltage: 12V/24V/9-30V

NG12008-1



LED侧标志灯

型号: NG12008-1
描述: LED具有高亮度、功率低、密封性好、寿命长、100%防水性的特点。
LED数量: 3
电压: 12V/24V/9-30V
Side Lamp LED
Type Number: NG12008-1
Description: LED has high brightness, low power, good sealing and long life, 100% waterproof.
LED quantity: 3
Voltage: 12V/24V/9-30V

NG12008-2



LED侧标志灯

型号: NG12008-2
描述: LED具有高亮度、功率低、密封性好、寿命长、100%防水性的特点。
LED数量: 3
电压: 12V/24V/9-30V
Side Lamp LED
Type Number: NG12008-2
Description: LED has high brightness, low power, good sealing and long life, 100% waterproof.
LED quantity: 3
Voltage: 12V/24V/9-30V

NG12009



LED侧标志灯

型号: NG12009
描述: LED具有高亮度、功率低、密封性好、寿命长、100%防水性的特点。
LED数量: 2
电压: 12V/24V
Side Lamp LED
Type Number: NG12009
Description: LED has high brightness, low power, good sealing and long life, 100% waterproof.
LED quantity: 2
Voltage: 12V/24V/9-30V

NG12010

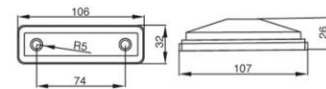

LED侧标志灯

型号: NG12010
描述: LED具有高亮度、功率低、密封性好、寿命长、100%防水性的特点。
电压: 12V/24V
Side Lamp LED
Type Number: NG12010
Description: LED has high brightness, low power, good sealing and long life, 100% waterproof.
Voltage: 12V/24V

NG12011



LED侧标志灯

型号: NG12011
描述: LED具有高亮度、功率低、密封性好、寿命长、100%防水性的特点。
电压: 12V/24V
Side Lamp LED
Type Number: NG12011
Description: LED has high brightness, low power, good sealing and long life, 100% waterproof.
Voltage: 12V/24V

NG12012

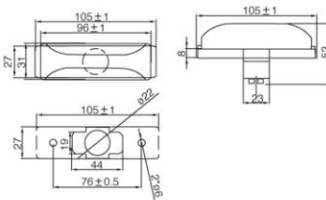

LED侧标志灯

型号: NG12012
描述: LED具有高亮度、功率低、密封性好、寿命长、100%防水性的特点。
电压: 12V/24V
Side Lamp LED
Type Number: NG12012
Description: LED has high brightness, low power, good sealing and long life, 100% waterproof.
Voltage: 12V/24V

NG12013

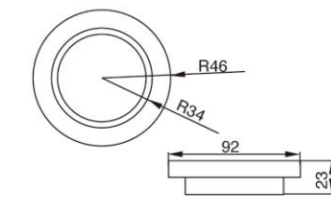

LED侧标志灯

型号: NG12013
描述: LED具有高亮度、功率低、密封性好、寿命长、100%防水性的特点。
电压: 12V/24V
Side Lamp LED
Type Number: NG12013
Description: LED has high brightness, low power, good sealing and long life, 100% waterproof.
Voltage: 12V/24V

NG12014

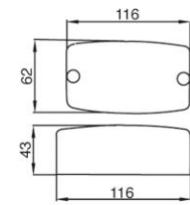

LED侧标志灯

型号: NG12014
描述: LED具有高亮度、功率低、密封性好、寿命长、100%防水性的特点。
电压: 12V/24V
Side Lamp LED
Type Number:NG12014
Description:LED has high brightness, low power,good sealing and long life, 100% waterproof.
Voltage:12V/24V

NG12015

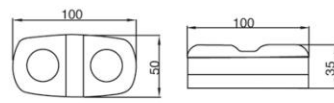

LED侧标志灯

型号: NG12015
描述: LED具有高亮度、功率低、密封性好、寿命长、100%防水性的特点。
电压: 12V/24V
Side Lamp LED
Type Number:NG12015
Description:LED has high brightness, low power,good sealing and long life, 100% waterproof.
Voltage:12V/24V

NG12017

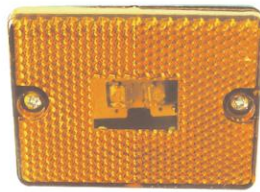

LED侧标志灯

型号: NG12017(原NG02018-2)
描述: LED具有高亮度、功率低、密封性好、寿命长、100%防水性的特点。
LED数量: 2
电压: 12V/24V/9-30V
Side Lamp LED
Type Number:NG12017
Description:LED has high brightness, low power,good sealing and long life, 100% waterproof.
LED quantity:2
Voltage:12V/24V/9-30V

NG12018



LED侧标志灯

型号: NG12018
安装孔位: 118mm
孔位直径: 4mm
描述: LED具有高亮度、功率低、密封性好、寿命长、100%防水性的特点。
LED数量: 16
电压: 12V/24V/9-30V
Side Lamp LED
Type Number:NG12018
Description:LED has high brightness, low power,good sealing and long life, 100% waterproof.
LED quantity:16
Voltage:12V/24V/9-30V

NG12025



LED侧标志灯

型号: NG12025
安装孔位: 50.5mm
孔位直径: 4mm
描述: LED具有高亮度、功率低、密封性好、寿命长、100%防水性的特点。
LED数量: 3
电压: 12V/24V/9-30V
E-MARK认证产品
Side Lamp LED
Type Number:NG12025
Description:LED has high brightness, low power,good sealing and long life, 100% waterproof.
LED quantity:3
Voltage:12V/24V/9-30V
E-MARK Authentication

NG16005



牌照灯

型号: NG16005
孔位直径: 26
License Plate Lamp
Type Nbmber: NG16005

NG16006



牌照灯

型号: NG16006
安装孔位: 76mm
孔位直径: 5mm
E-MARK认证产品
License Plate Lamp
Type Number:NG16006
E-MARK Authentication

NG16007



牌照灯

型号: NG16007
安装孔位: 45mm
孔位直径: 4mm
License Plate Lamp
Type Number:NG16007

NG18001



LED标杆灯

型号: NG18001
Pole Lamp LED
Type Number:NG18001

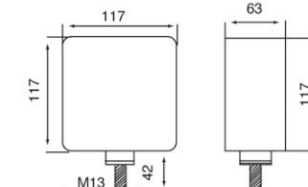

NG18002



LED标杆灯

型号: NG18002
Pole Lamp LED
Type Number:NG18002

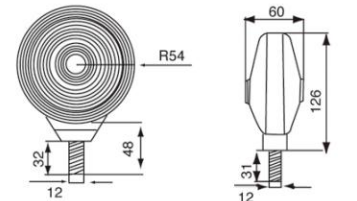

NG18021



LED侧向信号灯

型号: NG18021
LED Lateral Signal Lamp
Type Nbmber: NG18021

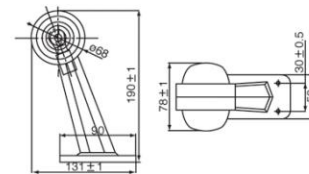

NG18022



LED侧向信号灯

型号: NG18022
LED Lateral Signal Lamp
Type Nbmber: NG18022

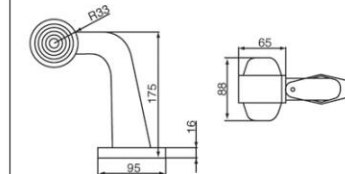

NG18031



LED报警灯

型号: NG18031
工作电压:DC12V/24V
颜色: 红色/黄色/蓝色/绿色
描述: 采用72颗超高亮LED, 带爆闪, 可加点烟器。
安装方式: 螺丝和自吸式强力铁磁铁。

NG18003



LED标杆灯

型号: NG18003
Pole Lamp LED
Type Number:NG18003

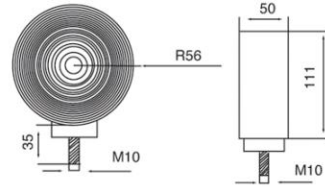

NG18008



LED工作灯

型号: NG18008(0215F)
LED功率: 15 W
工作电压:10-30V DC
防水: IP68
色温: 6000K
材料: 铸模铝外壳
透镜材料: 有机玻璃
安装支架: 不锈钢
LED Power: 15W
Operating Voltage:10-30V DC
Waterproof rate: IP68
Color temperature:6000K
Material: Diecast aluminum housing
Lens material:PMMA
Mounting bracket: Stainless Steel

NG18009



LED工作灯

型号: NG18009(0218F)
LED功率: 18W
工作电压:10-30V DC
防水: IP68
色温: 6000K
材料: 铸模铝外壳
透镜材料: 有机玻璃
安装支架: 不锈钢
LED Power: 18W
Operating Voltage:10-30V DC
Waterproof rate: IP68
Color temperature:6000K
Material: Diecast aluminum housing
Lens material:PMMA
Mounting bracket: Stainless Steel

NG18004



LED工作灯

型号: NG18004(0118F)
LED功率:18W
工作电压:10-30V DC
防水: IP68
色温: 6000K
材料: 铸模铝外壳
透镜材料: 有机玻璃
安装支架: 不锈钢
LED Power: 18W
Operating Voltage:10-30V DC
Waterproof rate: IP68
Color temperature:6000K
Material: Diecast aluminum housing
Lens material:PMMA
Mounting bracket: Stainless Steel

NG18005



LED工作灯

型号: NG18005(0127F)
LED功率: 27W
工作电压:10-30V DC
防水: IP68
色温: 6000K
材料: 铸模铝外壳
透镜材料: 有机玻璃
安装支架: 不锈钢
LED Power: 27W
Operating Voltage:10-30V DC
Waterproof rate: IP68
Color temperature:6000K
Material: Diecast aluminum housing
Lens material:PMMA
Mounting bracket: Stainless Steel

NG18010



LED工作灯

型号: NG18010(0310)
LED功率: 10W
工作电压:10-30V DC
防水: IP68
色温: 6000K
材料: 铸模铝外壳
透镜材料: 钢化玻璃
安装支架: 不锈钢
LED Power: 10W
Operating Voltage:10-30V DC
Waterproof rate: IP68
Color temperature:6000K
Material: Diecast aluminum housing
Lens material:Toughened glass
Mounting bracket: Stainless Steel

NG18011



LED工作灯

型号: NG18011(0312F)
LED功率: 12 W
工作电压:10-30V DC
防水: IP68
色温: 6000K
材料: 铸模铝外壳
透镜材料: PC
安装支架: 不锈钢
LED Power: 12W
Operating Voltage:10-30V DC
Waterproof rate: IP68
Color temperature:6000K
Material: Diecast aluminum housing
Lens material:PC
Mounting bracket: Stainless Steel

NG18006



LED工作灯

型号: NG18006(0142F)
LED功率: 42W
工作电压:10-30V DC
防水: IP68
色温: 6000K
材料: 铸模铝外壳
透镜材料: PC
安装支架: 不锈钢
LED Power: 42W
Operating Voltage:10-30V DC
Waterproof rate: IP68
Color temperature:6000K
Material: Diecast aluminum housing
Lens material:PC
Mounting bracket: Stainless Steel

NG18007



LED工作灯

型号: NG18007(0148)
LED功率: 48W
工作电压:10-60V DC
防水: IP68
色温: 6000K
材料: 铸模铝外壳
透镜材料: PC
安装支架: 不锈钢
LED Power: 48W
Operating Voltage:10-30V DC
Waterproof rate: IP68
Color temperature:6000K
Material: Diecast aluminum housing
Lens material:PC
Mounting bracket: Stainless Steel

NG18012



LED工作灯

型号: NG18012(0320F)
LED功率: 20 W
工作电压:10-30V DC
防水: IP68
可选颜色: 黑色、白色
色温: 6000K
材料: 铸模铝外壳
安装支架: 不锈钢
LED Power: 20W
Operating Voltage:10-30V DC
Waterproof rate: IP68
Optional Color:Brack/White
Color temperature:6000K
Material: Toughened glass
Mounting bracket: Stainless Steel

NG18013



LED工作灯

型号: NG18013(0403F)
LED功率: 30 W
工作电压:10-30V DC
防水: IP68
可选颜色: 黑色、白色
色温: 6000K
材料: 铸模铝外壳
透镜材料: 有机玻璃
安装支架: 不锈钢
LED Power: 30W
Operating Voltage:10-30V DC
Waterproof rate: IP68
Optional Color:Brack/White
Color temperature:6000K
Material: Diecast aluminum housing
Lens material:PMMA
Mounting bracket: Stainless Steel

NG18014



LED工作灯

型号: NG18014(0520F)
LED功率: 20 W
工作电压:10-30V DC
防水: IP68
可选颜色: 黑色、白色
色温: 6000K
透镜材料: 有机玻璃
安装支架: 不锈钢
LED Power: 20W
Operating Voltage:10-30V DC
Waterproof rate: IP68
Optional Color:Brack/White
Color temperature:6000K
Material: Diecast aluminum housing
Mounting bracket: Stainless Steel

NG18015



LED工作灯

型号: NG18015(0648F)
LED功率: 48 W
工作电压:10-60V DC
防水: IP68
可选颜色: 黑色、白色
色温: 6000K
材料: 铸模铝外壳
透镜材料: PC
安装支架: 不锈钢
LED Power: 48W
Operating Voltage:10-60V DC
Waterproof rate: IP68
Optional Color:Brack/White
Color temperature:6000K
Material: Diecast aluminum housing
Mounting bracket: Stainless Steel

NG18016



LED工作灯

型号: NG18016(0690F)
LED功率: 90W
工作电压:10-30V DC
防水: IP68
色温: 6000K
材料: 铸模铝外壳
透镜材料: PC
安装支架: 不锈钢
LED Power: 90W
Operating Voltage:10-30V DC
Waterproof rate: IP68
Color temperature:6000K
Material: Diecast aluminum housing
Lens Material:PC
Mounting bracket: Stainless Steel

NG18017



LED工作灯

型号: NG18017(0751F)
LED功率: 51W
工作电压:10-60V DC
防水: IP68
可选颜色: 黑色、红色
色温: 6000K
材料: 铸模铝外壳
透镜材料: 有机玻璃
安装支架: 不锈钢
LED Power: 51W
Operating Voltage:10-60V DC
Waterproof rate: IP68
Optional Color:Brack/Red
Color temperature:6000K
Material: Diecast aluminum housing
Lens material:PMMA
Mounting bracket: Stainless Steel

NG18018



LED工作灯

型号: NG18018(0845F)
LED功率: 45W
工作电压:10-30V DC
防水: IP68
可选颜色: 黑色、白色
色温: 6000K
材料: 铸模铝外壳
透镜材料: 有机玻璃
安装支架: 不锈钢
LED Power: 45W
Operating Voltage:10-30V DC
Waterproof rate: IP68
Optional Color:Brack/White
Color temperature:6000K
Material: Diecast aluminum housing
Lens material:PMMA
Mounting bracket: Stainless Steel

NG18019



LED工作灯

型号: NG18019(0850)
LED功率: 10W
工作电压:10-30V DC
防水: IP68
可选颜色: 黑色、白色
色温: 6000K
材料: 铸模铝外壳
透镜材料: 有机玻璃
安装支架: 不锈钢
LED Power: 50W
Operating Voltage:10-30V DC
Waterproof rate: IP68
Optional Color:Brack/White
Color temperature:6000K
Material: Diecast aluminum housing
Lens material:PMMA
Mounting bracket: Stainless Steel

NG18020



LED工作灯

型号: NG18020(9036)
LED功率: 15 W
工作电压:10-30V DC
防水: IP68
可选颜色: 黑色、白色
色温: 6000K
透镜材料: 有机玻璃
安装支架: 不锈钢
LED Power: 36W
Operating Voltage:10-30V DC
Waterproof rate: IP68
Optional Color:Brack/White
Color temperature:6000K
Material: Diecast aluminum housing
Lens material:PMMA
Mounting bracket: Stainless Steel

NG18040



LED工作灯

型号: NG18040
描述: LED具有亮度高、功率低、密封性好、寿命长、100%防水性的特点。
LED数量: 24
LED Work Lamp
Type Number: NG18040
Description: LED has high brightness, low power, good sealing and long life 100% waterproof.
Voltage:24V/12V/9-30V
LED quantity: 24

NG18041



LED工作灯

型号: NG18041
描述: LED具有亮度高、功率低、密封性好、寿命长、100%防水性的特点。
LED数量: 24
LED Work Lamp
Type Number: NG18041
Description: LED has high brightness, low power, good sealing and long life 100% waterproof.
Voltage:24V/12V/9-30V
LED quantity: 24

NG18042



LED工作灯

型号: NG18042
描述: LED具有亮度高、功率低、密封性好、寿命长、100%防水性的特点。
LED数量: 24
LED Work Lamp
Type Number: NG18042
Description: LED has high brightness, low power, good sealing and long life 100% waterproof.
Voltage:24V/12V/9-30V
LED quantity: 24

NG18303



LED工作灯

型号: NG18303
描述: LED具有亮度高、功率低、密封性好、寿命长、100%防水性的特点。
LED数量: 6
LED Work Lamp
Type Number: NG18303
Description: LED has high brightness, low power, good sealing and long life 100% waterproof.
Voltage:24V/12V/9-30V
LED quantity: 6

NG15040



水壶(200L)
型号: NG15040
Kettle
Tvne Number:NG15040

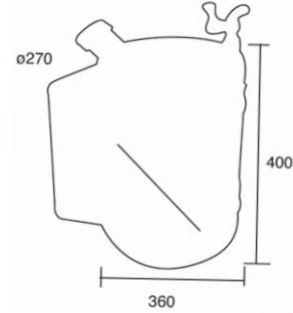

NG15041



车用水箱(450L)
型号: NG15041
尺寸: 长x高1620x608mm
Water Tank
Type Number:NG15041

NG15042



车用水箱(200L)
型号: NG15042
Water Tank
Type Number:NG15042

NG15060



环卫车水箱
型号: NG15060
Water Tank
Type Number:NG15060

NG15047

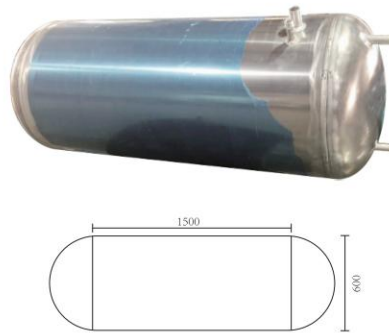

**搅拌车水箱
铝合金(480L)**
型号: NG15047
Water Tank
Type Number:NG15047

NG15043



搅拌车汽路控制盒
型号: NG15043
Type Number:NG15043

NG15044



搅拌车汽路控制盒
型号: NG15044
Type Number:NG15044

NG15045

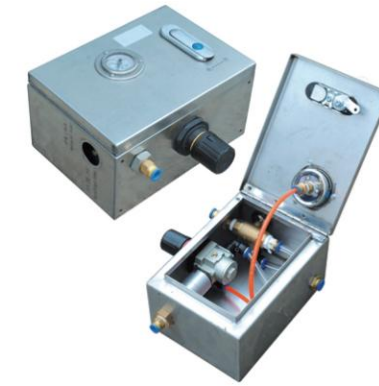

搅拌车汽路控制盒
型号: NG15045
Type Number:NG15045

NG15046



**混凝土搅拌车
四件套**
型号: NG15046
Type Number:NG15046

NG15048



搅拌车散热器
型号: NG15048
Type Number:NG15048

NG15049



搅拌车侧护栏支架
型号: NG15049
Type Number:NG15049

NG15050



灭火器箱
型号: NG15050
灭火器4-8kg
材料: 塑料
重量:3.7kg
Type Number:NG15048
Material:PP
Weight:3.7kg

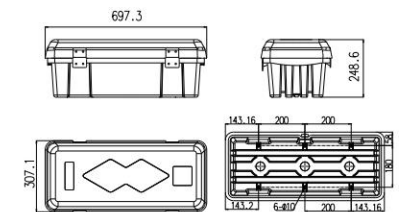

NG15051



塑料工具箱

型号: NG15051
适用于车辆车厢下面, 放于工具的箱子, 具有方便、轻巧、密封。

Material Tool Box
Apply the vehicle below to Put in the tool box with a convenient,light weight an sealing.

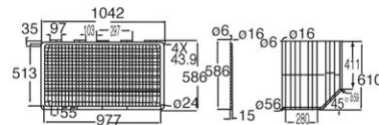

NG15051-1



塑料工具箱

型号: NG15051-1
适用于车辆车厢下面, 放于工具的箱子, 具有方便、轻巧、密封。

重量/Weight:16Kg
Material Tool Box
Apply the vehicle below to Put in the tool box with a convenient,light weight an sealing.

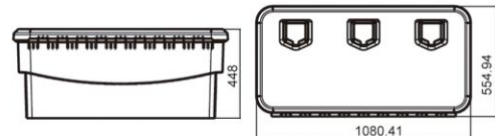

NG15051-2



塑料工具箱

型号: NG15051-2
适用于车辆车厢下面, 放于工具的箱子, 具有方便、轻巧、密封。

Material Tool Box
Apply the vehicle below to Put in the tool box with a convenient,light weight an sealing.

NG15052



不锈钢工具箱

型号: NG15052
适用于车辆车厢下面, 放于工具的箱子, 具有方便、轻巧、密封。

可根据客户要求定做

Material Tool Box
Apply the vehicle below to Put in the tool box with a convenient,light weight an sealing.

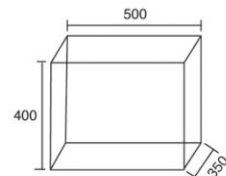

NG15055



不锈钢工具箱

型号: NG15055
适用于车辆车厢下面, 放于工具的箱子, 具有方便、轻巧、密封。

可根据客户要求定做

Material Tool Box
Apply the vehicle below to Put in the tool box with a convenient,light weight an sealing.

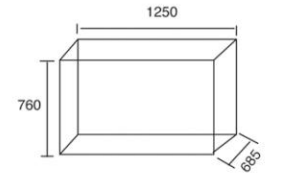

NG15056



不锈钢工具箱

型号: NG15056
适用于车辆车厢下面, 放于工具的箱子, 具有方便、轻巧、密封。

可根据客户要求定做

Material Tool Box
Apply the vehicle below to Put in the tool box with a convenient,light weight an sealing.

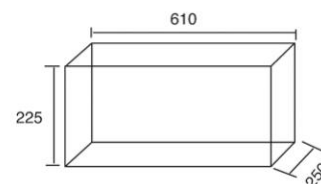

NG15057



铁工具箱

型号: NG15057
适用于车辆车厢下面, 放于工具的箱子, 具有方便、轻巧、密封。

可根据客户要求定做

Material Tool Box
Apply the vehicle below to Put in the tool box with a convenient,light weight an sealing.

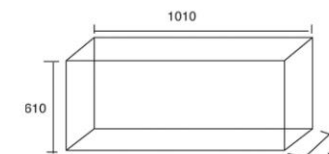

NG15058



料斗盖

型号: NG15058
Hopper Cover

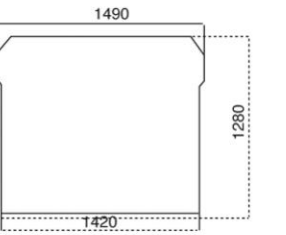

NG15053



铝合金工具箱

型号: NG15053
适用于车辆车厢下面, 放于工具的箱子, 具有方便、轻巧、密封。

可根据客户要求定做

Material Tool Box
Apply the vehicle below to Put in the tool box with a convenient,light weight an sealing.

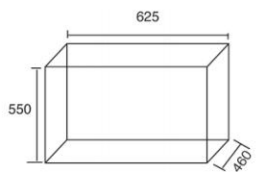

NG15054



铝合金工具箱

型号: NG15054
适用于车辆车厢下面, 放于工具的箱子, 具有方便、轻巧、密封。

可根据客户要求定做

Material Tool Box
Apply the vehicle below to Put in the tool box with a convenient,light weight an sealing.

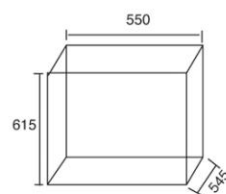

NG15061



料斗盖踏板

型号: NG15061
Type Number:NG15061
Hopper Cover Pedal

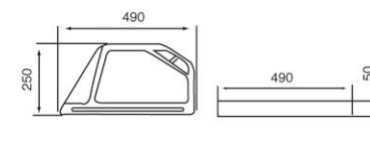

NG15065



车用电器控制盒

型号: NG15065
Car's electrical control box
Type Number:NG15065

NG15066



车用电器控制盒
型号: NG15066
Car's electrical control box
Type Number:NG15066

NG15067



车用电器控制盒
型号: NG15067
Car's electrical control box
Type Number:NG15067

NG15068



铝合金工具箱(304包边)
型号: NG15068
适用于车辆车厢下面, 放于工具的箱子, 具有方便、轻巧、密封。
可根据客户要求定做

Material Tool Box
Apply the vehicle below to
Put in the tool box with a
convenient,light weight an
sealing.

NG15069



工具箱
型号: NG15069
适用于车辆车厢下面, 放于工具的箱子, 具有方便、轻巧、密封。
可根据客户要求定做

Material Tool Box
Apply the vehicle below to
Put in the tool box with a
convenient,light weight an
sealing.

NG15070

后保险杠



NG15071 铝合金侧护栏

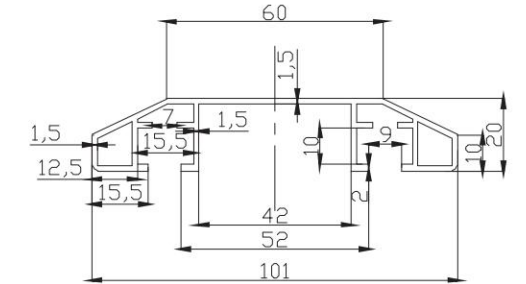

规格:100x20mm

NG15072 铝合金侧护栏

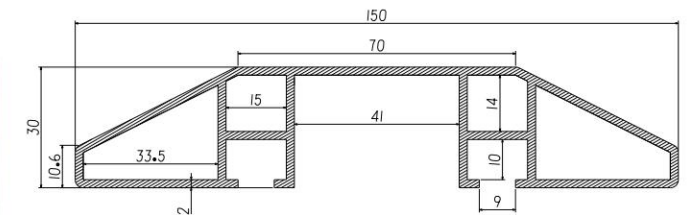
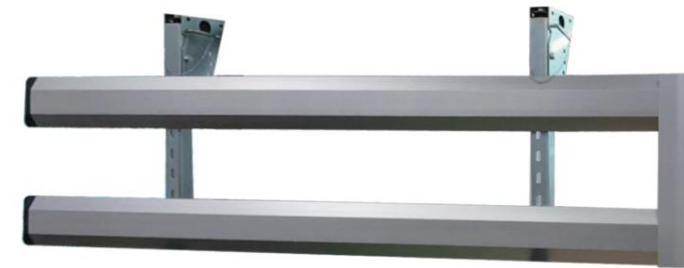

规格:150x30mm

NG15073 铝合金侧护栏

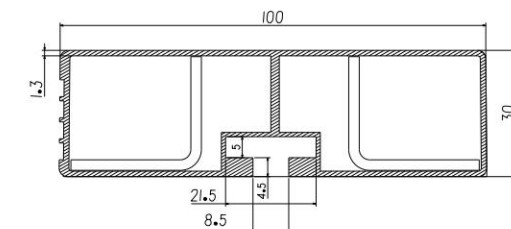
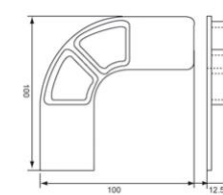

Material: Aluminum
Weight: 1.21kg/m
Finish: Qxide coating

材料: 铝
重量: 0.5kg/m
表面处理: 氧化
Material: Aluminum
Weight: 0.5kg/m
Finish: Oxide coating

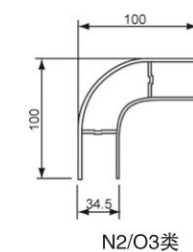

规格: 100x30mm

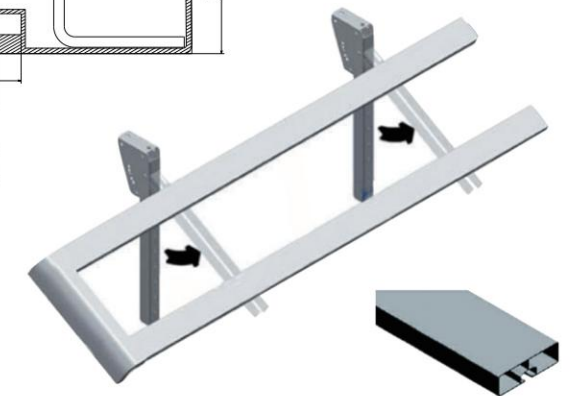

NG15074 铝合金侧护栏保护支架

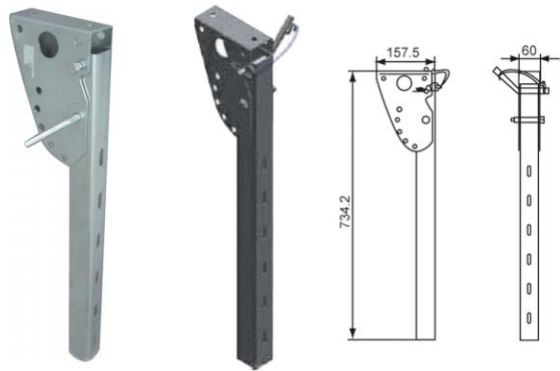

材料: 钢/不锈钢
重量: 3.75kg/m/2.35kg/m
表面处理: 镀锌/抛光
Material: Steel/INOX
Weight: 3.75kg/m/2.35kg/m
Finish: Zinc/Polishing

NG15075 备胎升降器



NG15076 环卫车塑料控制盒



全自动软篷系统

本机构是我们目前最新款产品,从以前的杠杆传动,液压传动到现在的链条传动。平滑式渣土车箱盖装置具备国际领先的水平全密闭装置,能确保渣土车运输过程中全部密闭,有效解决渣土车运输过程中的抛、洒、滴、漏等老大难问题。此外,该装置设计上既考虑让渣土车适量增加装载,又避免了渣土车的盲目超载问题。



产品优点

- 1、渣土车运输过程中全面密闭,彻底解决运输过程中的抛洒滴漏等问题;
- 2、装置适用所有车型,不受车型大小、长短等因素限制;
- 3、适量加大了车斗的装载空间,增加了装载量,又有效控制无限的超载超高;
- 4、装置非常结实耐用,并且维护也非常方便;
- 5、重量轻,装货更多。篷布顶盖的重量几乎可以忽略不计,与传统的液压驱动的;金属顶盖相对,电动软篷系统能多装近1吨的渣土。

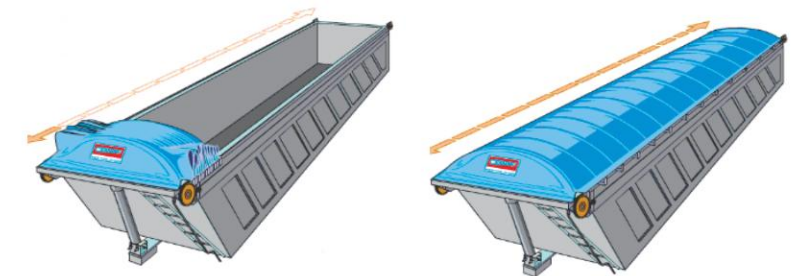

产品配置

部件名称	图片	参数	部件名称	图片	参数
电机总成		24V,600W, 电动转速1800r/min, 减速机rv050, 输入转速45r/min	板带		PVC,T=3mm, 规格:5700*70
链条		型号: 10A, GB/T 1243-1997, L=0.8米	滑轮		
篷布		双面防水, 工业涤纶丝+PVC 防雨、防晒、遮阳	控制盒总成		24V, 过载电流50A, 三键式,带两个遥控器, 带空开。



热塑性蜂窝板材产品

蜂窝板采用多层有方向性的连续玻璃纤维增强聚丙烯带材，与聚丙烯蜂窝芯热复合而成，是一种热塑性轻质蜂窝夹心三明治结构。芯材为PP蜂窝，就是这款蜂窝芯。愉悦公司的蜂窝芯，安全环保无毒。

*热塑性芯材的厚度在4-50mm之间，可根据客户需求切割定制。

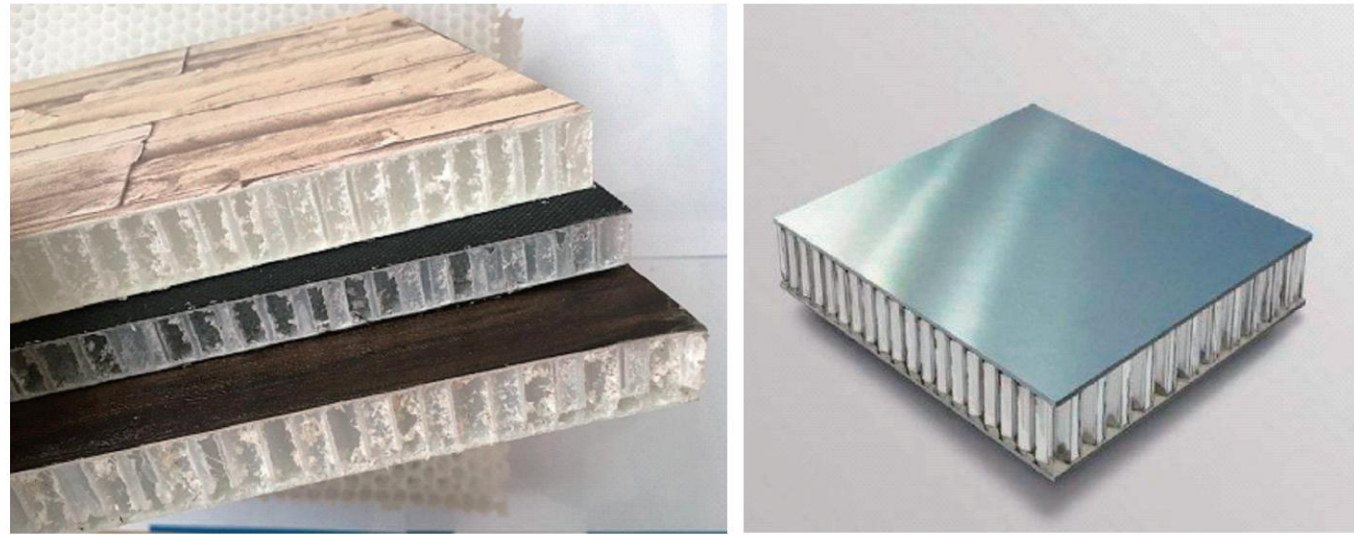
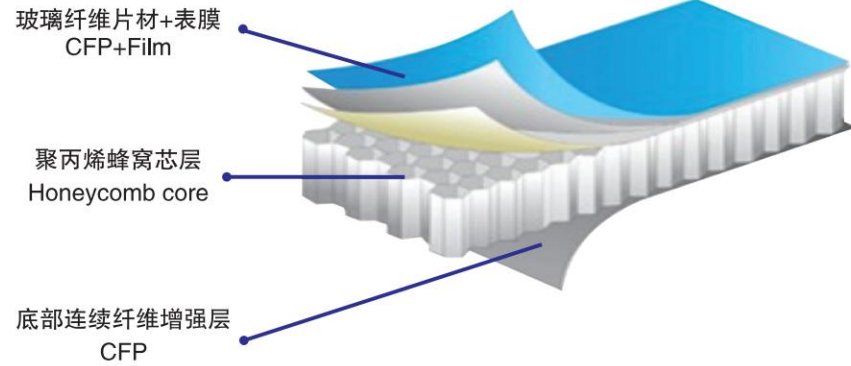

1、使用原理

热塑性复合蜂窝板具有高比强度、高韧性、耐腐蚀性、环保节能性、质量轻等特点，在汽车、飞机、航天器、潜艇等能耗性高的领域，拥有广阔的市场空间。

2、应用领域

- (1) 物流运输行业
- (2) 汽车卡车制造业
- (3) 建筑施工行业
- (4) 航空航天行业
- (5) 铁路公路建设等行业
- (6) 新型能源行业。

3、应用优势

- (1) 原材料是聚丙烯，原材料充足，能够有效替代金属板、纸板、胶合板、木板等，有广阔市场前景。
- (2) 原材料采用环保无毒的聚丙烯产品，能够100%回收利用，不对大自然产生危害。
- (3) 轻质高强，耐候性强，抗腐蚀，能有效延长产品的使用寿命。

热塑性蜂窝板材组装厢体的方式：热塑性复合蜂窝板材，通过定制好侧板顶板尾板等的尺寸，配置好相应的抽芯铆钉、铝合金材料等，就可以简单安装好一个厢体。

*我司承接制作货车厢车，欢迎广大公司联系洽谈业务。

热塑性蜂窝芯材产品

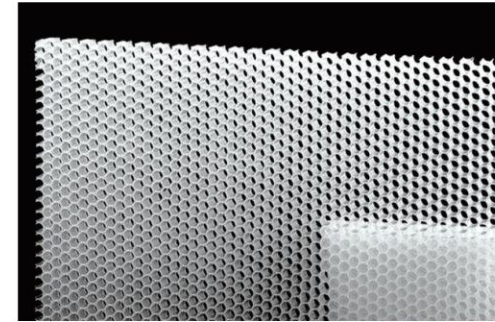

热塑性蜂窝芯材具有轻质高强、绿色环保、防水防潮和耐腐蚀等特点，可以和不同的面材（如玻璃钢、木纹板、铝板、不锈钢板、大理石、橡胶板等）进行复合。可以大规模替代传统材料，广泛应用于厢式货车、高铁、航空航天、游艇、家居、移动建筑等领域，主要有以下几个型号：A型（内径8mm）B型（内径10mm）C型（内径12mm），由于内径不同，密度和压缩强度以及重量也有不同。



技术参数表

型号 Type	A型	B型	B型
颜色 Colour	白色/White	白色/White	白色/White
内径 Internal diameter(mm)	8	10	12
密度 Density(kg/m ³)	80~120	75~120	70~110
压缩强度 Compressive Sttength(Mpa)	1.62	1.55	1.45
压缩模量 Compressive Modulus(Mpa)	44.5	40.8	38.5
剪切强度 Shear Strength(Mpa)	0.5	0.45	0.4
使用温度 Temperature(°C)	-40—+80	-40—+80	-40—+80
热绝缘性 U值 Thermal Insulation Uvalue(W/m ² K)	2.2	2.2	2.2

产品实例



货车车厢



临时建筑板房的墙体地板



风电设备舱罩面



游艇甲板上层和舱壁

厢式汽车上装厢体

为主机车厂，改装车配套服务为物流企业服务，CKD生产模式轻量化、高强度、高效率。

厢体特点

1. 厢板结构与性能

厢板可选用整体式玻璃钢厢板，无拼接接缝，高强度，轻量化，易修补，外表面光洁平整等特点，还可选用彩钢板及整体式铝板厢板，以满足不同客户的需求！

2. 厢体总体设计

上装厢体部分采用板块式拼接结构，以高强度铝合金型材包边固定，采用铆接结构，装配方便，简单易操作，根据各种厢体的结构性能，结合客户的要求，进行优化配置，最大程度的满足客户的需求！

3. 上装厢体与底盘连接

厢体地板骨架与汽车底盘的大梁(半挂车和集装箱除外)连接为高强度调制的U型螺栓连接，并配以上下连接板固定，保证上装厢体的前窜，螺栓及连接板均为可拆卸连接，方便车辆的二次改装！

4. 车辆附件配备

车辆除按标准配备侧护栏、后保险杠外，还可方便使用客户要求选装侧门爬梯，后门爬梯及后端液压升降围板等装置，以上设备均采用可拆卸螺栓结构，以方便以上装备的检查和维修。

冷藏厢式车、干货厢式车



农业机械塑件



大型农机轮眉



植保药箱

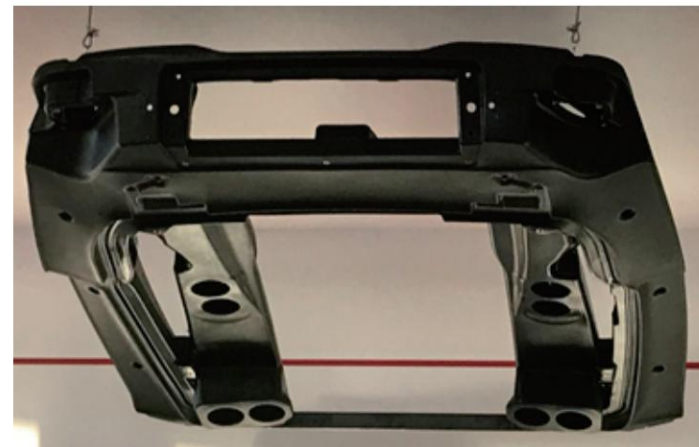

带空调通风管的拖拉机顶棚



液压油箱



油箱



水箱

农业机械塑件



农业机械塑件



汽车尾板



液压装卸台产品

我公司专业为厂家设计制造各种规格、承载、高度的液压升降机、翻转式装卸台。配有护栏，装卸台举升高度最高可达2.5米以上、承载质量1吨以上。该型号的液压装卸平台，可直接安装、固定在水泥地面或基座上，通过液压叉车将货物推送到装卸平台，方便装车，大幅提高装卸效率。



汽车液压起重尾板



产品型号

尾板型号	最大起重重量	电瓶电压	车厢最大离地高度	油缸内径	U型架尺寸	备注
NGWB-10/120	1吨	12V/24V	1.20米	63mm	850mm	普通型
NGWB-15/130	1.5吨	12V/24V	1.30米	80mm	950mm	普通型
NGWB-20/140	2吨	24V	1.40米	80mm	950mm	加长型

汽车尾板是安装于箱式货车和栏板车尾部的一种液压装卸机构。由机械、液压传动和电气控制组成。它以汽车上的蓄电池为动力源，可完成重达上千公斤货物的装卸。具有的快速、安全、高效的特点，大幅度节省人力、提高装卸效率，是现代化物流运输的必备设备之一。广泛用于邮政、金融、石化、商业、食品、物流、制造等各行业。

